

# SigTEL Compact

## Emergency Voice Communication System (EVCS)

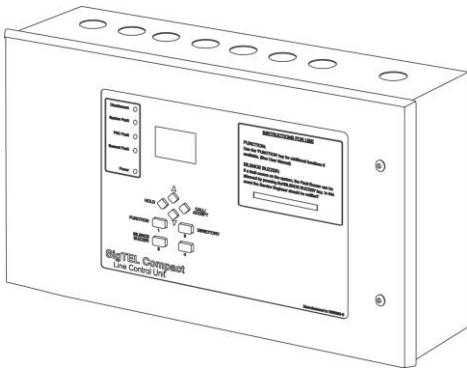
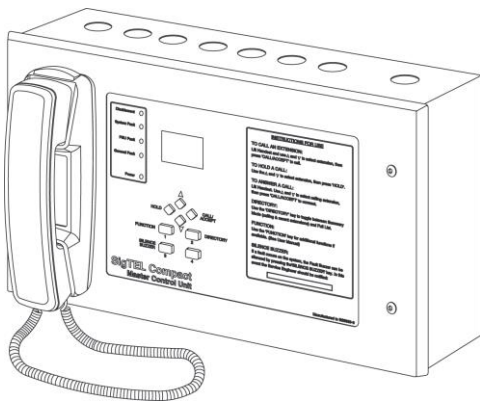

## Installation and Configuration Manual

Approved Document No. DAU0000091 Rev 3

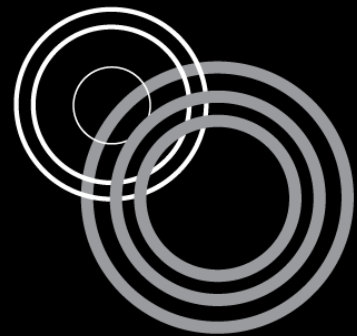

AN EXPLANATION OF TERMS AND DEFINITIONS USED IN THESE INSTRUCTIONS IS LISTED IN SECTION 23.

## Contents

<b>1</b>	<b>IMPORTANT NOTES</b> .....	<b>4</b>
<b>2</b>	<b>REGULATIONS AFFECTING EVCS</b> .....	<b>4</b>
<b>3</b>	<b>SIGTEL COMPACT COMPONENTS</b> .....	<b>5</b>
3.1	MCU (PART NO. ECU-8 OR ECU-4) .....	5
3.2	LCU (PART NO. ECU-8NT).....	5
3.3	EXPANSION UNIT (PART NO. ECU-8S) .....	5
3.4	GREY FLUSH BEZEL (PART NO. AFP385) .....	5
3.5	TYPE A FIRE TELEPHONE OUTSTATION (PART NO. EVC301RPO/EVC301RLK) .....	5
3.6	FLUSH-MOUNTING BEZEL (PART NO. T-BEZ301).....	5
3.7	TYPE B DISABLED REFUGE OUTSTATION - SURFACE MOUNTED (PART NO. EVC302S/GS).....	6
3.8	TYPE B DISABLED REFUGE OUTSTATION - FLUSH MOUNTED (PART NO. EVC302F/GF).....	6
3.9	TYPE B OUTSTATION ENCLOSURE (PART NO. BF359/1) .....	6
3.10	MCU ENCLOSURE (PART NO. BF359/3D) .....	6
3.11	DISABLED PERSONS TOILET ALARM (PART NO. NC951) .....	6
3.12	NETWORK COMMUNICATIONS CARD (PART NO. ECU721).....	6
	3.12.1 Key features of the EVCS networked system: .....	7
<b>4</b>	<b>CABLES</b> .....	<b>7</b>
<b>5</b>	<b>TYPICAL SYSTEMS</b> .....	<b>8</b>
5.1	SYSTEM UP TO 4 EXTENSIONS (SHOWN RIGHT) .....	8
5.2	SYSTEM UP TO 8 EXTENSIONS (SHOWN LEFT).....	8
5.3	SYSTEM UP TO 16 EXTENSIONS.....	9
5.4	NETWORKED SYSTEM UP TO 64 EXTENSIONS.....	10
<b>6</b>	<b>FIRST FIX INSTALLATION</b> .....	<b>11</b>
6.1	EQUIPMENT LOCATION .....	11
<b>7</b>	<b>MOUNTING MCU AND EXPANSION UNIT ENCLOSURES</b> .....	<b>12</b>
7.1	REMOVE THE BASE PCBs .....	12
7.2	REMOVE THE LID .....	13
7.3	REMOVE KNOCKOUTS & CUT GLAND HOLES .....	13
7.4	INTERCONNECTIONS.....	13
7.5	FIX THE BASE TO THE WALL .....	13
7.6	RE-INSTALL THE PCBs .....	14
<b>8</b>	<b>INSTALLING THE ECU721 NETWORK COMMS CARD (OPTIONAL)</b> .....	<b>15</b>
<b>9</b>	<b>NETWORK CONNECTIONS (OPTIONAL)</b> .....	<b>16</b>
<b>10</b>	<b>MAINS WIRING</b> .....	<b>17</b>
<b>11</b>	<b>FITTING OUTSTATIONS &amp; DPTA INTERFACE</b> .....	<b>18</b>
11.1	CABLES.....	18
11.2	LOCATION .....	18
11.3	FITTING TYPE A OUTSTATION (EVC301RPO/EVC301RLK) .....	18
11.4	FITTING TYPE B OUTSTATION (EVC302S/GS AND EVC302F/GF) .....	18
11.5	WIRING TO A DISABLED PERSONS TOILET ALARM (DPTA) .....	18

**12 TESTING EXTENSIONS..... 19**

12.1 INSULATION RESISTANCE TESTING..... 19

12.2 THE FITT LINE TESTER..... 19

**13 SECOND FIX INSTALLATION ..... 19**

13.1 CONNECTING EXTENSIONS TO THE MCU AND EXPANSION UNIT..... 19

13.2 FAULT MONITORING..... 19

13.3 INPUT CONNECTIONS..... 20

13.4 OUTPUT CONNECTIONS..... 20

**14 MCU INDICATORS & CONTROLS ..... 21**

14.1 EXTERNAL INDICATORS ..... 21

14.2 THE DISPLAY ..... 21

14.3 EXTERNAL CONTROLS ..... 22

14.4 INTERNAL CONTROLS ..... 22

**15 FAULT MESSAGES..... 23**

**16 POWERING UP AND TESTING ..... 23**

**17 AUTOMATIC CONFIGURATION ..... 25**

17.1 NON-NETWORKED MCU CONFIGURATION ..... 25

17.2 NETWORKED MCU CONFIGURATION..... 26

17.3 ADDING OR REPLACING MCU, OUTSTATIONS OR DPTA AFTER COMMISSIONING..... 28

17.4 DEFAULT EXTENSION NAMES..... 28

17.5 NAMING EXTENSIONS..... 28

    17.5.1 Interactive naming ..... 29

    17.5.2 Manual naming ..... 29

    17.5.3 EVC Configurator ..... 29

**18 ADDITIONAL ENGINEER FUNCTIONS..... 30**

18.1 CHANGE THE SECURITY PIN CODE ..... 30

18.2 HARMONISE NAMES (NETWORKED SYSTEM ONLY) ..... 30

18.3 LATCH FAULTS..... 31

18.4 CLEAR RECENT CALLS ..... 32

18.5 AUTO-ANSWER ..... 32

**19 COMPONENT SPECIFICATIONS ..... 33**

**20 EVCS STANDBY BATTERY CALCULATION GUIDE ..... 34**

**21 ENHANCED FEATURES ..... 35**

21.1 FIRMWARE VERSION..... 35

**22 INSTALLATION AND COMMISSIONING CERTIFICATE..... 36**

**23 TERMS AND DEFINITIONS..... 37**

©Errors and omissions excepted. The manufacturer of this product operates a policy of continuous improvement and reserves the right to alter product specifications at its discretion and without prior notice. All of the instructions covered in this manual have been carefully checked prior to publication. However, no responsibility can be accepted by the manufacturer for any inaccuracies, or any misinterpretations of an instruction or guidance note.

## 1 Important Notes

### READ THIS SECTION BEFORE INSTALLING/MAINTAINING THIS PRODUCT



#### CAUTION

This equipment must only be installed and maintained by a suitably skilled and technically competent person. No responsibility can be accepted by the manufacturer, or distributors of this product for any misinterpretation of an instruction, or guidance note, or for the compliance of the system as a whole.

#### About this guide

This guide explains how to install, commission and maintain a SigTEL EVCS disabled refuge and fire telephone system. A separate user manual (ref. DAU0000092) includes detailed operational information, some of which will need to be referred to by the installation engineer when setting up the system.

No responsibility can be accepted by the manufacturer, or distributors for any misinterpretation of these instructions, or for the compliance of the system as a whole.

**This installation guide must not be accessible to the user.**

#### System design

EVCS design is beyond the scope of this document. An understanding of system components and their use is assumed.

We recommend that you read BS 5839 Part 9 (available in libraries or from the BSI, [www.bsonline.bsi-global.com](http://www.bsonline.bsi-global.com)) for this information. Contact the building control, or fire officer in case he has any special requirements.

#### Equipment guarantee

This equipment is not guaranteed unless the system is installed and commissioned in accordance with national standards by an approved and competent person, or organisation.

#### General precautions

Do not test wiring with an insulation tester (Megger) with any equipment connected as the 500 volt test will destroy these devices totally. You must observe local wiring regulations.

Do not run SELV and LV cables in the same enclosure without adequate insulation between them.

SigTEL EVCS control equipment is designed to be installed indoors. Outstations are not IP rated so should not be installed outdoors unless an IP65, or better housing, is used and cables are installed so as to prevent the ingress of moisture.

#### Anti-static handling guidelines



Make sure that electro-static handling precautions are taken immediately before handling PCBs and other static sensitive components. Before handling any static-sensitive items, Operators should get rid of any electrostatic charge by touching a sound safety earth.

Always handle PCBs by their sides and avoid touching any components. PCBs should be stored in a clean, dry place that is free from vibration, dust and excessive heat. Storing the PCBs in a suitable cardboard box will also guard them against mechanical damage.

## 2 Regulations Affecting EVCS

Disabled refuge systems are called for by DETR Approved document B (Fire safety) volume 2, section 4, Design for vertical escape and BS 5588 Fire precautions in the design, construction and use of buildings, Part 8, Code of practice for means of escape for disabled people.

Fire telephone systems for buildings are called for by BS 5588 Fire precautions in the design, construction and use of buildings Part 5, Code of practice for firefighting stairs and lifts, Part 10, Code of practice for shopping complexes and Part 11, Code of practice for shops, offices, industrial, storage and other similar buildings.

Fire telephone systems for sports venues are called for by the Guide to safety at sports grounds.

The installation of EVCS's is covered by BS 5839-9 Fire detection and fire alarm systems for buildings – Part 9: Code of practice for the design, installation, commissioning and maintenance of emergency voice communication systems.

### 3 SigTEL Compact Components

**Note:** See Specification (section 19) for component details.

#### 3.1 MCU (part no. ECU-8 or ECU-4)

The master control unit (MCU) controls the EVCS and allows the MCU's Operator to communicate with the outstations.

Each MCU has either eight extensions (ECU-8) or four extensions (ECU-4).

This can be increased to 16 extensions using an Expansion Unit with an ECU-8, or to 12 extensions using an Expansion Unit with an ECU-4. One extension typically has one outstation (Type A or B) or a DPTA connected to it.

A flush mounting bezel (AFP385) and an anti-tamper enclosure (BF359/3D) are available to house the unit.

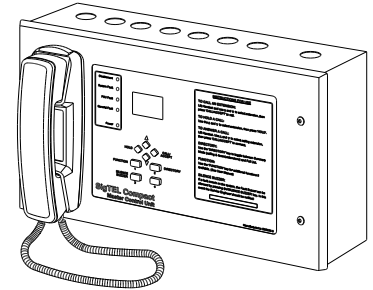

**Note:** Up to four MCUs can be connected on a network by installing a Network Communications Card (ECU721) in each unit.

#### 3.2 LCU (part no. ECU-8NT)

The line control unit (LCU) is identical to an MCU (ECU-8) but it does not have a handset mounted on its front fascia.

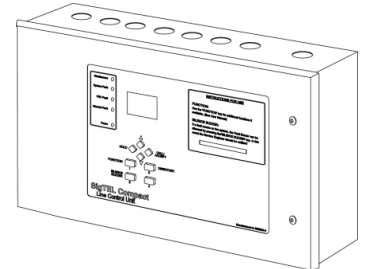

#### 3.3 Expansion Unit (part no. ECU-8S)

This unit has 8 extensions and increases the number of extensions that can be connected to a controller (MCU or LCU). It must be fitted next to a controller.

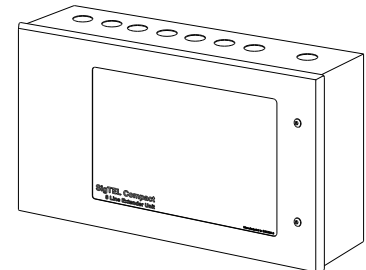

#### 3.4 Grey flush bezel (part no. AFP385)

This flush bezel is used with the MCU, LCU or Expansion Unit and provides a neat finish when an enclosure is semi-recessed (up to 60 mm).

#### 3.5 Type A Fire Telephone Outstation (part no. EVC301RPO/EVC301RLK)

One Type A outstation is connected to one extension so that the control room can call out to specific locations and also know which location is calling in.

The outstation consists of a telephone-style handset housed within a wall-mounted, red steel case. Two versions are available a magnetic 'push to open' version (EVC301RPO) right, and a 'lift lock' version (EVC301RLK) used to prevent unauthorised access.

Both units can be surface mounted, or a flush mounting bezel (T-BEZ301) is available.



#### 3.6 Flush-mounting bezel (part no. T-BEZ301)

This red flush bezel provides a neat finish when the EVC301RPO/EVC301RLK is semi-recessed.

**3.7 Type B Disabled Refuge Outstation - surface mounted (part no. EVC302S/GS)**

One Type B outstation is connected to one extension so that the control room can call out to specific locations and also know which location is calling in. The EVC302S has a stainless steel fascia and the EVC302GS has a green mild steel fascia. Both units use hands-free, duplex operation and have a 'Push to Call or Answer' button, Call in Progress LED, buzzer and apertures for a microphone and loudspeaker.



**3.8 Type B Disabled Refuge Outstation - flush mounted (part no. EVC302F/GF)**

Identical to the EVC302S/GS version but with a flat fascia suitable for flush installation. The EVC302F has a stainless steel fascia and the EVC302GF has a green mild steel fascia. An IP66 rated housing (BF359/1) is available to allow the EVC302F/GF to be used outdoors.



**3.9 Type B outstation enclosure (part no. BF359/1)**

This weatherproof enclosure is used to protect an EVC302F/GF outstation when used at an external disabled refuge. It is supplied with a non-locking handle (as disabled refuge points should not normally be locked) and has an IP66 rating.

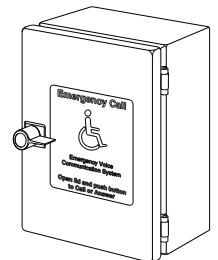

**3.10 MCU enclosure (part no. BF359/3D)**

This is a stainless steel, anti-tamper enclosure used to house an MCU. It is supplied with two optional locking kits; BF359/3CL (camlock kit) or BF359/3SL (solenoid kit).

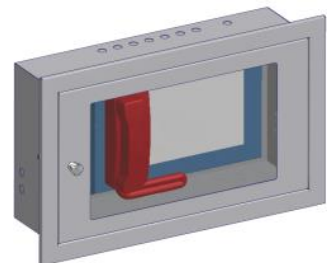

**3.11 Disabled persons toilet alarm (part no. NC951)**

The EVCS is able to interface with a disabled persons toilet alarm (DPTA) system. This is a secondary function to the primary purpose of the EVCS. If the site has toilet alarms AND they are connected into the EVCS, then active toilet alarms will be displayed at the MCU. As toilet alarm monitoring is a secondary function, any activated toilet alarms will be suppressed from being displayed if there are any calls from/to the outstations. At the end of outstation calls, the activated toilet alarms will then be displayed.



**3.12 Network communications card (part no. ECU721)**

The ECU721 Network Communications Card enables up to four MCUs or LCUs to be connected on a communication network, up to 1 km in length. Any MCU/LCU connected on the network requires the installation of an ECU721 card which is mounted inside the control unit and transmits both speech audio and digital data.

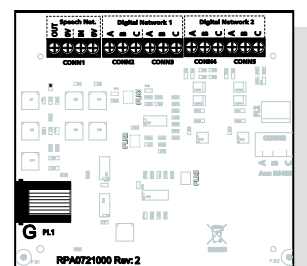

### 3.12.1 Key features of the EVCS networked system:

1. Allows the interconnection of up to four MCUs using 4 x 2-core, 1.5 mm<sup>2</sup>, enhanced wiring.
2. Maximum length on the speech wiring loop, or digital linear wiring = 1 km.
3. Each MCU monitors both the network wiring and each other for faults (open and short circuits).
4. Fault tolerant network that allows the system to continue working in the event of a single cable break in the speech or digital wiring. Speech audio is transmitted via one wiring loop and digital data via two linear RS485 networks.
5. Each networked MCU can be programmed with the following configuration:
  - One MCU is configured as the 'master' MCU and has control over the system. The other MCU act as repeaters but can take control from the master MCU when a security PIN code is entered, either at the master MCU, or a repeater MCU. For example, control can be transferred from one control point in a building to another to cater for different day/night shift patterns.
  - The master MCU displays the location of calls and the description of faults on the EVCS. Faults on repeater MCU are displayed at the master MCU as a General Fault.
  - Calls from any outstation, regardless of which MCU they are connected to, are automatically routed to the master MCU. Repeater MCU indicate that units are calling the master MCU and can take control of the system by picking up their handsets and entering a security PIN code.
  - Able to take control from the master MCU at any repeater MCU (by entering a security PIN code). For example, the nearest MCU to the building entry point. Also, able to give control from the master MCU to any repeater MCU (by entering a security PIN code).
  - Changes made at the master MCU (e.g. security PIN codes, extension names, addition/removal of an outstation or MCU) are automatically updated on all repeater MCU.
  - The master MCU is automatically dialled to by a repeater MCU when their handsets are picked up (no-call mode).

## 4 Cables

Generally, cables used between EVCS components, and for the low voltage Mains supply to the system, should be enhanced fire-resistant [see 26.2e of BS 5839-1:2002+A2:2008]. Please note the following exceptions.

BS 5839-9:2010 section 14 the following recommendations are applicable:

c) Standard fire resisting cables [see BS 5839-1:2002+A2:2008, 26.2d] should be considered to provide sufficient resistance to the effects of fire with appropriate methods of support and jointing [see BS 5839-1:2002+A2:2008, 26.2g] for:

- 1) EVC systems for use in disabled refuges but not for fire-fighting or similar purposes by, e.g. the fire and rescue service, in:
  - i) sprinklered buildings;
  - ii) unsprinklered buildings less than 30 m in height, provided that evacuation takes place in three or fewer phases.
- 2) Underground sections of cabling at sports and similar venues.

Interconnection	Cable Type
Extensions to outstations	2-core, 1.0 mm <sup>2</sup> or 1.5 mm <sup>2</sup> cable is recommended for each extension. Larger cables will stress the connectors. The maximum cable resistance is 40 ohms, which is 1000 metres of 1.0 mm <sup>2</sup> . If this is exceeded audio quality will degrade.
Extensions to DPTA systems (NC951)	2-core cable is required for each extension.
MCU (ECU-8 or ECU-4) to Expansion Unit (ECU-8S)	Connect the MCU to Expansion Unit using two Cat 5 patch cables (supplied with the Expansion Unit). These cables are not fire-resistant and some of the cores are not monitored for faults. Therefore, they must be protected to BS 5839 standards by joining the two cabinets with a short length of 25 mm steel conduit (min 45 mm, max 60 mm) and passing the cables through.
Power supplies	The MCU requires fixed wiring using 2-core cable and earth/CPC cable (no less than 0.75 mm <sup>2</sup> and no more than 2.5 mm <sup>2</sup> ) fed from an isolating switched fused spur, fused at 3 amps. Must not be connected using a plug and socket.
Networked systems  MCU to MCU or MCU to LCU	4 x 2-core, 1.5 mm <sup>2</sup> , up to 1000 metres in length. This cable connects ECU721 cards mounted inside the MCU.  <b>Note:</b> To provide full network reliability only 2-core cable should only be used. This allows two separate cable paths to be run with each path containing a single speech and data cable (which should not be mixed in the same cable). Therefore, if one cable path's integrity is compromised, because of structural damage, the other cable path's integrity is maintained.
MCU to ECU721 – networked system	Connect the MCU to ECU721 using one Cat 5 patch cable (supplied with ECU721).

## 5 Typical Systems

### 5.1 System up to 4 extensions (shown right)

**Equipment required**

- One MCU (ECU-4), requires two 12 volt 7 Ah batteries (BC286/2)
- One 3 A fused spur and back box
- One Type A Outstation (EVC301RPO/RLK), or one Type B Outstation (EVC302F/GF/S/GS), or one DPTA (NC951) per extension
- One Telephone Line Tester (FiTT)

**Interconnections**

- For each extension to outstation: up to 1 km of 2-core, 1.5 mm<sup>2</sup> enhanced fire-rated cable.
- For each extension to DPTA (NC951): 2-core enhanced fire-rated cable.

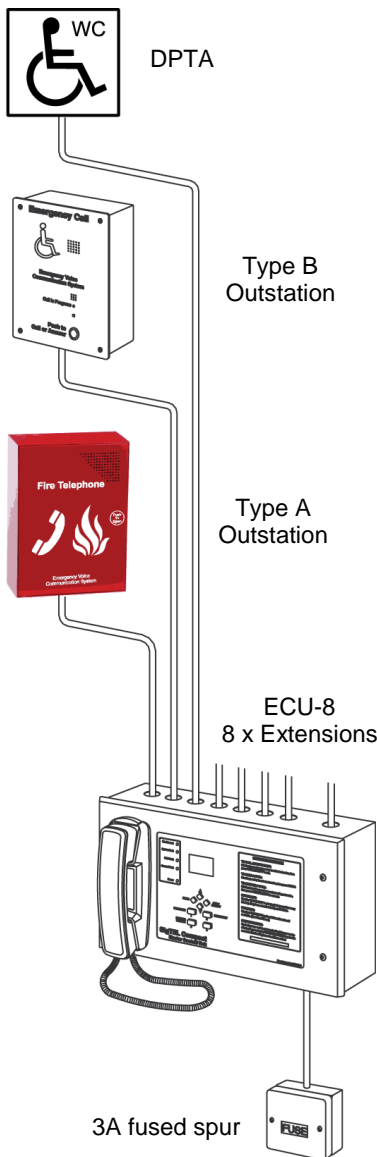
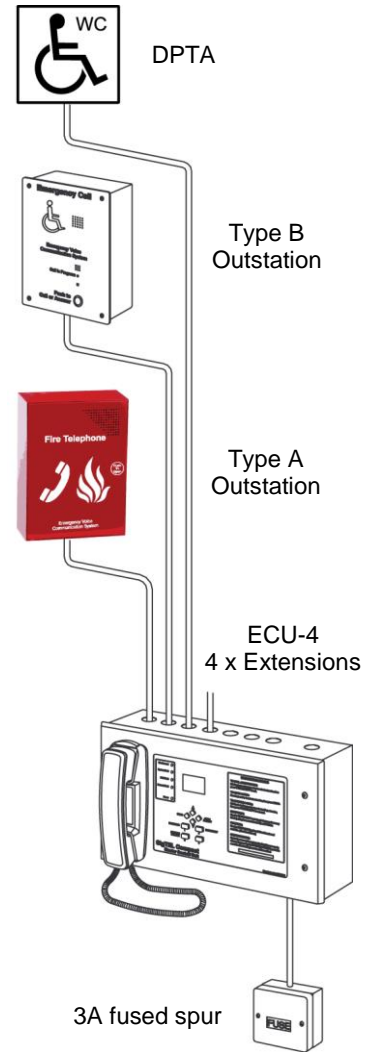

### 5.2 System up to 8 extensions (shown left)

**Equipment required**

- One MCU (ECU-8), requires two 12 volt 7 Ah batteries (BC286/2)
- One 3 A fused spur and back box
- One Type A Outstation (EVC301RPO/RLK), or one Type B Outstation (EVC302F/GF/S/GS), or one DPTA (NC951) per extension
- One Telephone Line Tester (FiTT)

**Interconnections**

- For each extension to outstation: up to 1 km of 2-core, 1.5 mm<sup>2</sup> enhanced fire-rated cable.
- For each extension to DPTA (NC951): 2-core enhanced fire-rated cable.



**5.3 System up to 16 extensions**

**Equipment required**

One MCU (ECU-8), requires two 12 volt 7 Ah batteries (BC286/2)

One Expansion Unit (ECU-8S)

One 3 A fused spur and back box

One Type A Outstation (EVC301RPO/RLK), or one Type B Outstation (EVC302F/GF/S/GS), or one DPTA (NC951) per extension

One Telephone Line Tester (FiTT)

**Interconnections**

For each extension to outstation: up to 1 km of 2-core, 1.5 mm<sup>2</sup> enhanced fire-rated cable.

For each extension to DPTA (NC951): 2-core enhanced fire-rated cable.

Between the MCU and the Expansion Unit: two Cat 5 cables (supplied) protected by 25 mm steel conduit.

Minimum distance between the MCU and Expansion Unit (so that the doors will open properly): 45 mm.

Maximum distance between the MCU and Expansion Unit (so the supplied cables will not be too short): 60 mm.

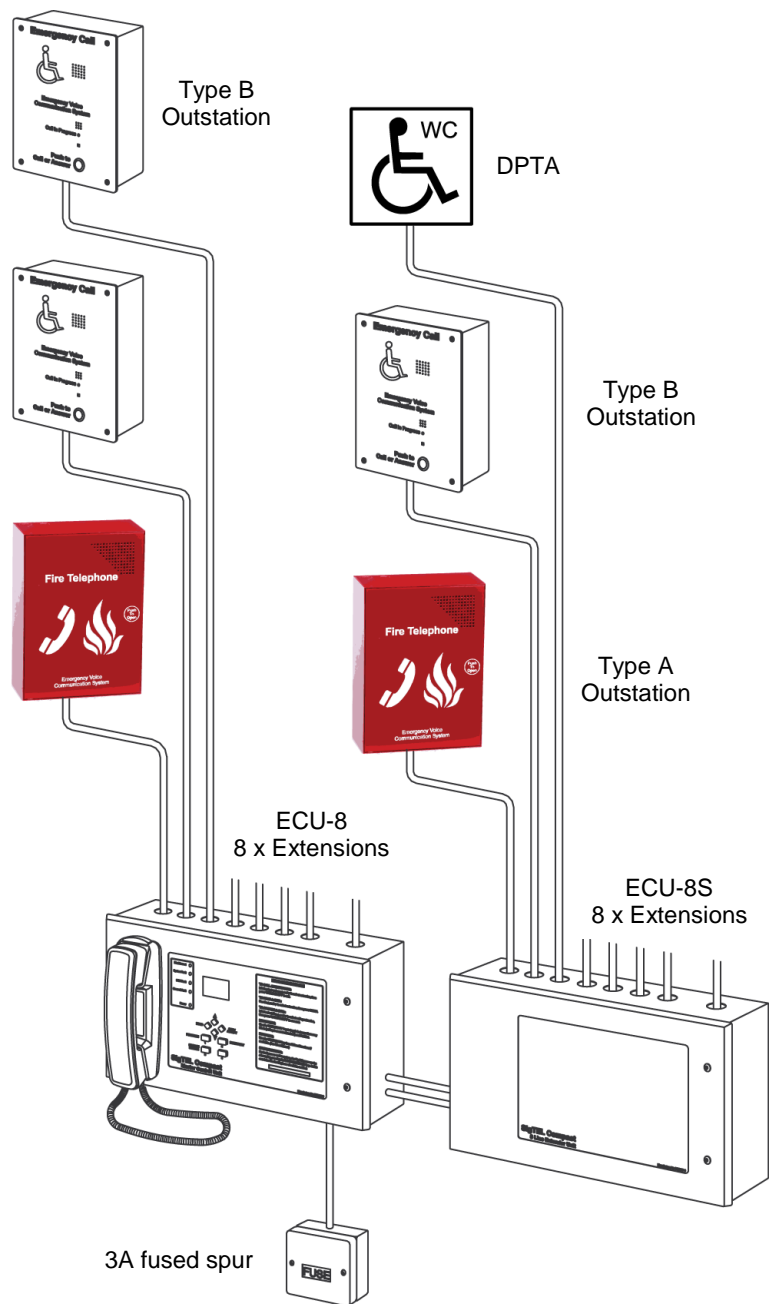

**5.4 Networked system up to 64 extensions**

**Equipment required**

- Up to four MCU (ECU-8), requires two 12 volt 7 Ah batteries (BC286/2) per MCU
- One Expansion Unit (ECU-8S) per MCU (if required)
- One 3 A fused spur and back box per MCU
- One Type A Outstation (EVC301RPO/RLK), or one Type B Outstation (EVC302F/GF/S/GS), or one DPTA (NC951) per extension
- One Telephone Line Tester (FiTT) per MCU

**Interconnections**

- For each extension to outstation: up to 1 km of 2-core, 1.5 mm<sup>2</sup> enhanced fire-rated cable.
- For each extension to DPTA (NC951): 2-core enhanced fire-rated cable.
- Between each MCU and Expansion Unit: two Cat 5 cables (supplied) protected by 25 mm steel conduit.
- Minimum distance between the MCU and Expansion Unit (so that the doors will open properly): 45 mm
- Maximum distance between the MCU and Expansion Unit (so the supplied cables will not be too short): 60 mm.
- Network Connections (MCU to MCU): 4 x 2-core, 1.5 mm<sup>2</sup>, enhanced fire-rated cable. This allows two separate cable paths (Cable Paths 1 & 2) to be run with each path containing a single speech and data cable (which should not be mixed in the same cable). The network wiring is fault-tolerant - see network diagram (section 9).

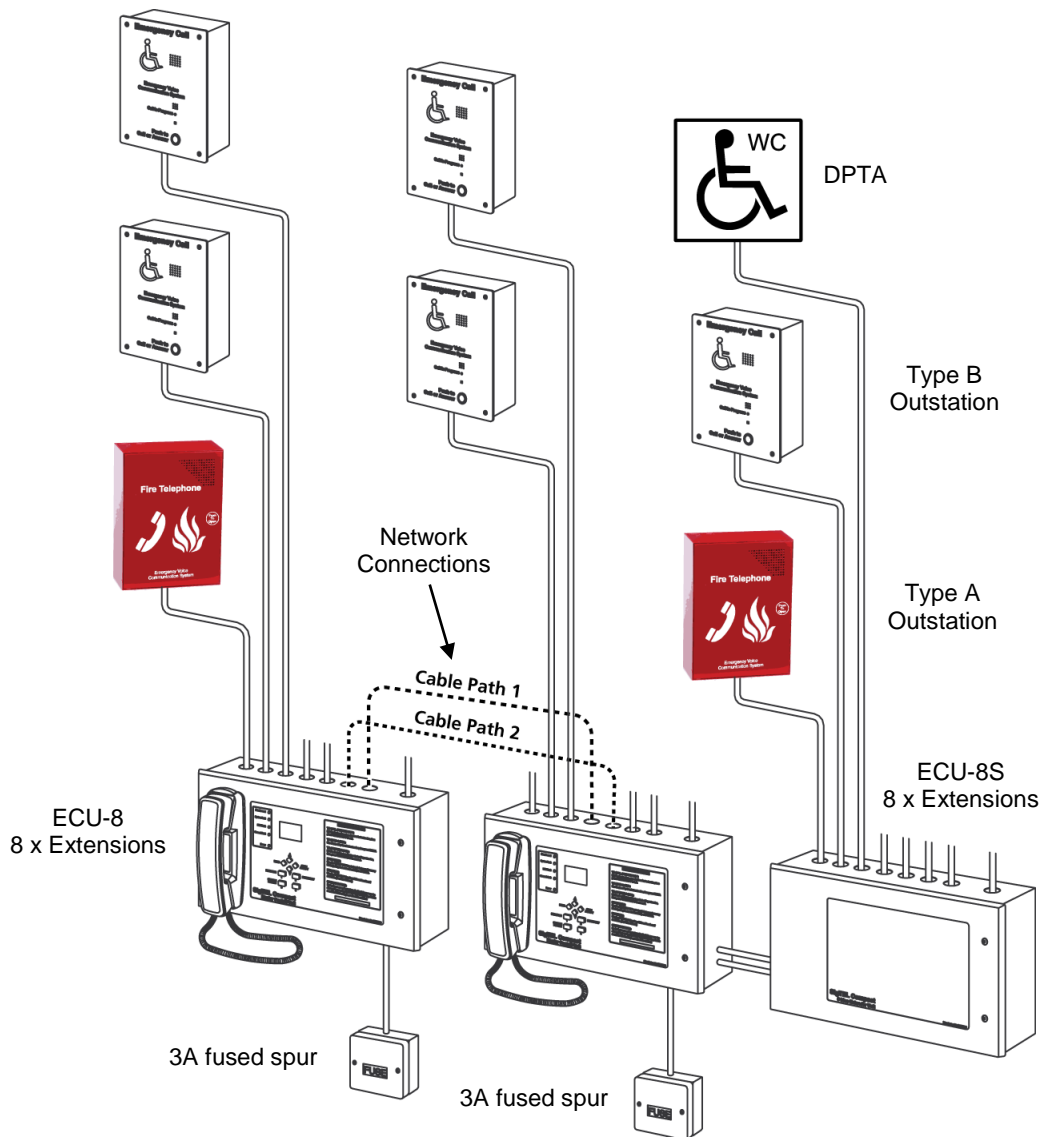

## **6 First Fix Installation**

### **6.1 Equipment location**

#### **Control equipment**

Unless installed in an enclosure of at least IP65 rating, all equipment must be sited indoors and **MUST NOT** be subjected to conditions likely to affect its performance, such as damp, salt air, water, extreme temperatures, physical abuse, etc. As far as practical, control equipment should be located where background noise is normally low (preferably not more than 40 dBA).

If an additional enclosure is used for any component, care must be taken to ensure that the functionality of the components is not impaired. For example, all indicators must be visible and necessary tones must be audible at the levels required by BS 5839-9 when the door is closed.

The MCU and Expansion Unit must be wall mounted at an easily accessible height, with the LCD at eye level, typically 1.4 metres above final floor level and should be located in areas of low fire risk, usually in the control room.

#### **Outstations**

Type A outstations should be located at entrances and fire fighting lobbies and normally mounted 1.3 m to 1.4 metres above final floor level. Type B outstations should be located in disabled refuges at each storey exit and normally mounted 0.9 to 1.2 metres above final floor level.

As far as practical, outstations should be located where background noise is normally low (preferably not more than 40 dBA). Where there is a higher level of background noise, the installation of an acoustic hood around the outstation may help to reduce the effect of background noise to an acceptable level

#### **Disabled persons toilet alarm (DPTA) System**

Refer to the documentation supplied with the DPTA (Part No. NC951).

#### **Outdoor installations**

Outstations may be mounted in an IP65 enclosure with an easily opened door. Steps should be taken to ensure that moisture does not enter and damage the electronics and that necessary functionality is not impaired.

#### **Sports stadiums**

In sports stadiums, Type A outstations should be located no more than 30 metres from stewards' positions, or other normally manned areas as listed in the Guide to Safety in Sports Grounds. If they are exposed to the elements they should be mounted in an IP65 enclosure with an easily opened door. Steps should be taken to ensure that moisture does not enter and damage the electronics and that necessary functionality is not impaired.

#### **Strobe driver module (part no. SDM)**

If the ringer is not loud enough a flashing red strobe light and/or sounder may be fitted to any outstation.

A strobe driver module, part number SDM, which can switch up to one amp, should be connected across the line to sense when the outstation rings.

An external 12 VDC EN 54 power supply must be connected to the strobe module to provide power for the module and/or sounder. This may be provided local to the outstation, or centrally, in which case two extra cores will be required and voltage drop should be taken into account.

## 7 Mounting MCU and Expansion Unit Enclosures

The MCU (ECU-8 or ECU-4) and Expansion Unit (ECU-8S) are supplied in a steel back-box with a hinged steel lid and several printed circuit boards (PCBs), as shown below.

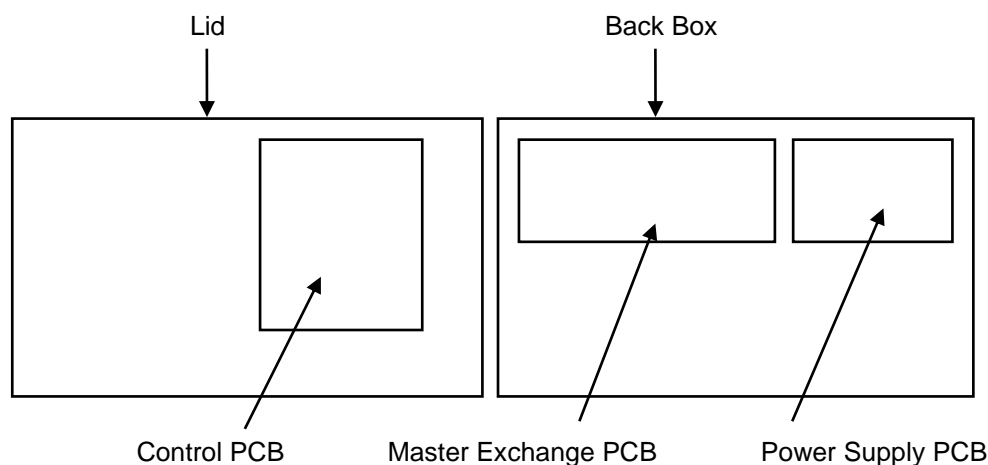

**MCU**

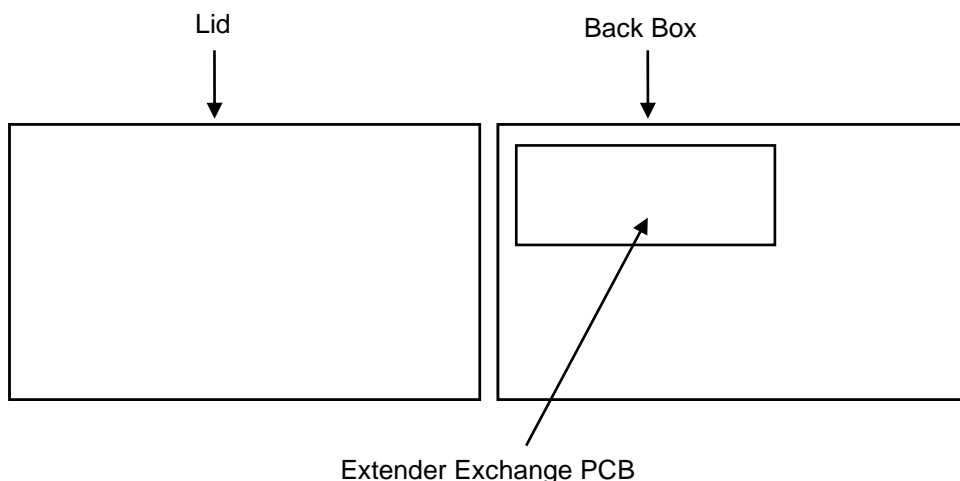

**Expansion Unit**

The MCU and Expansion Unit can be surface, or semi-flush mounted to allow clearance for front fascia opening (max. depth 60 mm including dimples). To expose the base mounting holes and to protect the hinged lid and PCBs from damage during installation, they must first be removed. Before any of the following is carried out ensure that the Mains power supply is isolated and the batteries are removed.

### 7.1 Remove the base PCBs

Disconnect the cable from the PSU to the Exchange PCB and the earth strap from the base to the lid.  
 Disconnect the earth strap spade connector from the main chassis earth point.  
 Carefully remove the PCB retaining screw located at the bottom left hand side of the exchange and power supply PCBs.  
 Push the PCB upwards and then pull forwards over the mounting pillars taking care not to damage any of the components.

**7.2 Remove the lid**

Undo the two screws on the right hand side of the lid using the tool supplied. Hinge the lid fully to the left. Unplug the earth strap and the two RJ45 plugs on the wiring looms. Carefully remove the four M4 retaining nuts that secure the hinges.

**The MCU lid and base PCBs should now be removed from site to prevent accidental damage.**

**Note:** All PCBs are static sensitive and anti-static handling precautions MUST be observed when handling them.

**7.3 Remove knockouts & cut gland holes**

Mains should normally be brought into the case via a knockout in the bottom right-hand corner. However, if top-entry is required, it should enter through the knockout on the extreme right. Cable segregation must be maintained.

If the MCU is fully populated with extensions then extra 20 mm holes may be cut in the top, as required.

**Note:** This must be done before re-installation of circuit boards to avoid swarf getting into the electronics.

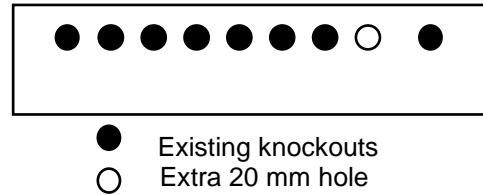

**7.4 Interconnections**

If an Expansion Unit is to be fitted, cut a suitable hole in the side of each box and fit a steel conduit large enough for the two Cat 5 cables (and their plugs) and one earth lead to pass through, as shown below.

**Note:** This must be done before re-installation of circuit boards to avoid swarf getting into the electronics.

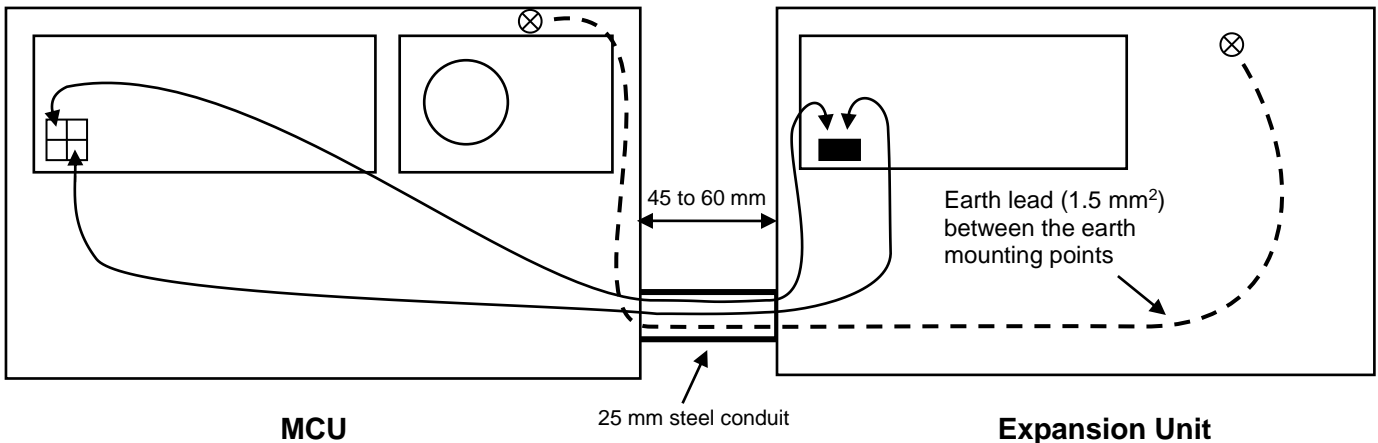

**7.5 Fix the base to the wall**

Using the four mounting holes, fix the base securely to the wall using a suitable screw fixing. The mounting holes are designed for No. 8 round-head, or countersunk wood-screws. Any dust, or swarf, must be kept out of the enclosure and great care must be taken not to damage the wiring, or components.

**7.6 Re-install the PCBs**

Re-install the base PCBs and refit the lid. Ensure the fixing screws and all interconnection cables are refitted correctly, as shown below.

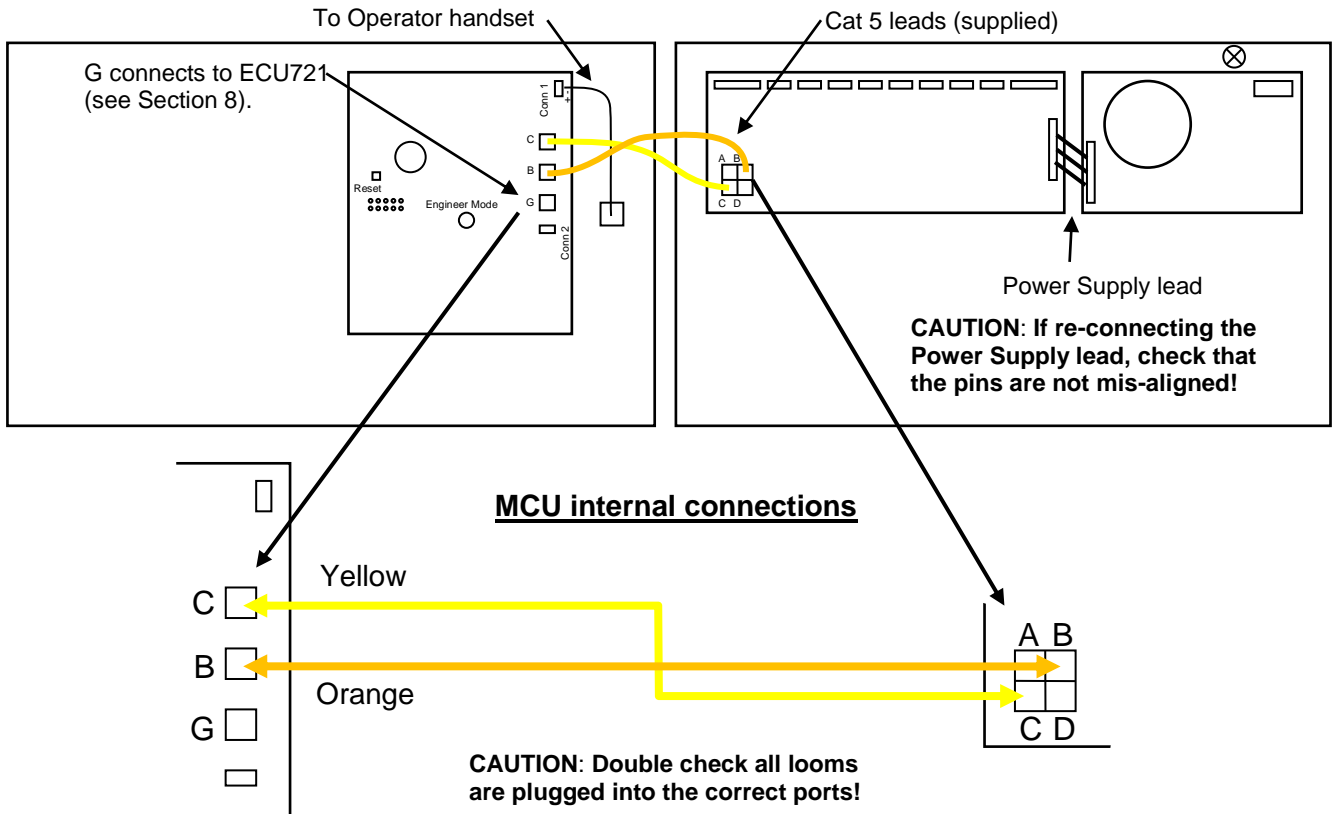

If you are using an Expansion Unit connect it to the MCU as shown below.

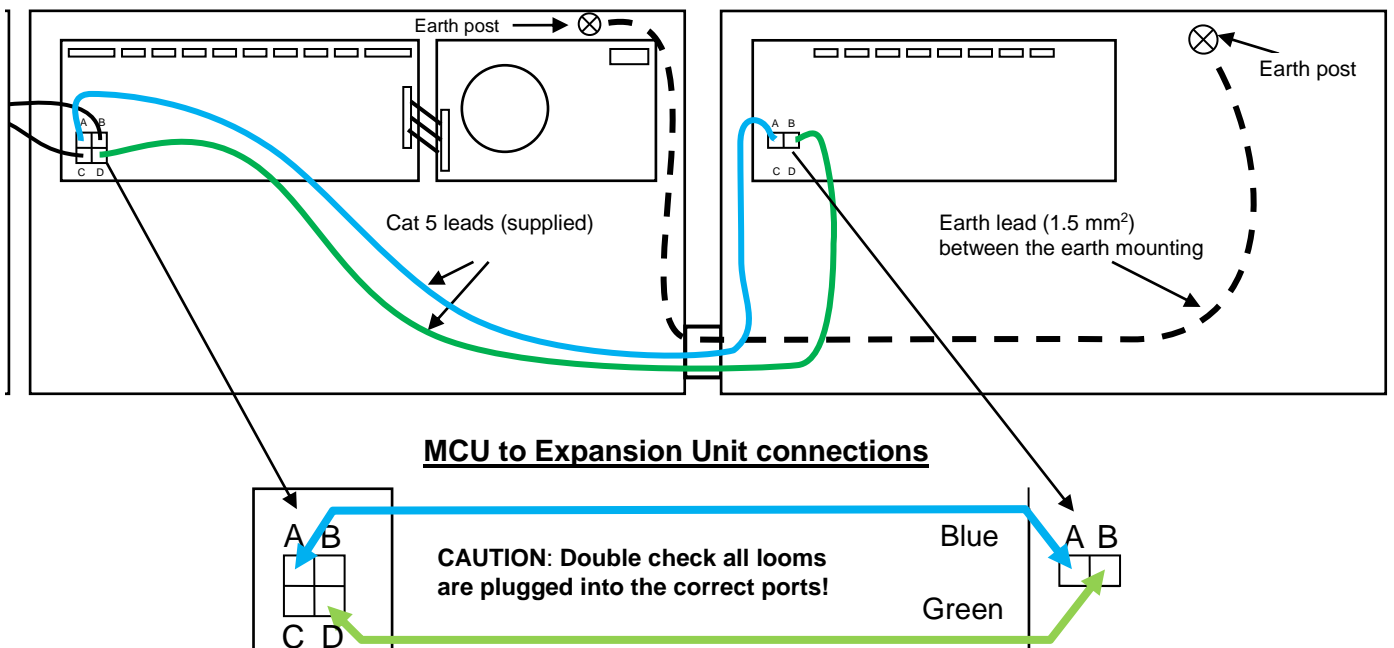

## 8 Installing the ECU721 Network Comms Card (Optional)

The MCU has a Master Exchange PCB and Power Supply PCB mounted in its base unit and a lid-mounted Control PCB. The ECU721 card has to be mounted on top of the Master Exchange PCB. Before carrying out the steps below, ensure that Mains power is isolated and the MCU batteries are disconnected.

**Note:** All PCBs are static-sensitive and therefore anti-static handling precautions **MUST** be observed when handling them.

To install an ECU721 card follow the steps below:

1. Open the MCU lid by removing the two retaining lid screws (using an Allen key).
2. Disconnect the 10-way wiring loom between the Master Exchange PCB and the Power Supply PCB. Ensure the loom remains connected to the Power Supply PCB to prevent it being misplaced.
3. Unplug the RJ45 connectors from terminals B&C on the Master Exchange PCB. Ensure these cables remain connected to the Control PCB to prevent them being misplaced. Care should be taken when detaching these connectors to depress the locking tabs to prevent damage.
4. Unfasten the one retaining screw, located bottom left side on the Master Exchange PCB, using a crosshead screwdriver. Carefully slide the Master Exchange PCB up and over its mounting pillars, taking care not to damage any components.
5. Take the ECU721 card and carefully line up its four holes with the holes in the Master Exchange PCB, see right.
6. Insert four M3 x 15 mm slotted screws and hex spacers (supplied) through the front holes in both the ECU721 card and Master Exchange PCB so they protrude through the back of the PCB. Next, secure the ECU721 card and PCB together using four M3 nuts (supplied), see right.
7. Refit the Master Exchange PCB (and mounted ECU721 card) back into the base unit. Ensure the retaining screw on the Master Exchange PCB is firmly fastened down. Reconnect the RJ45 leads and 10-way wiring loom.
8. Connect a 270 mm RJ45 patch lead (supplied) from terminal G on the ECU721 card to terminal G on the lid-mounted Control PCB. See below.

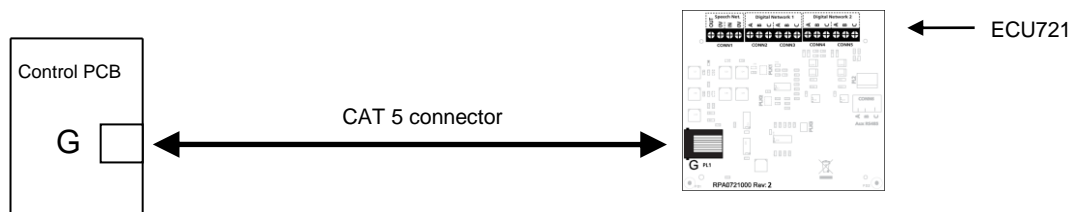
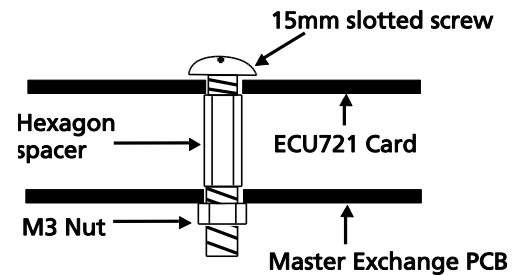
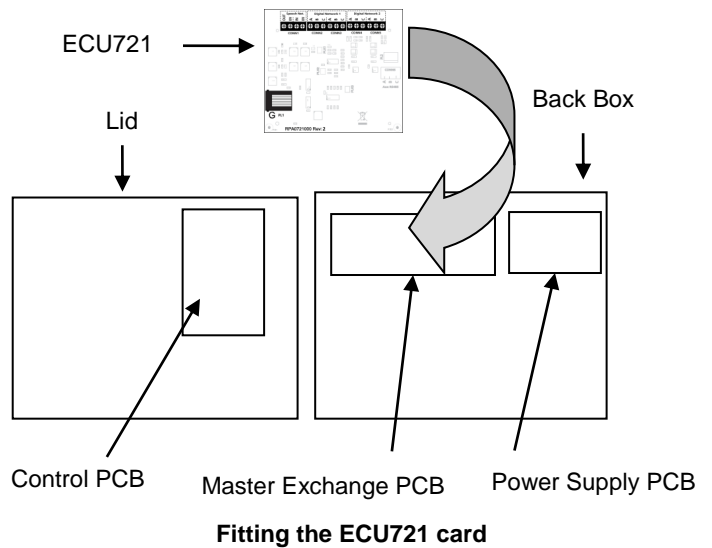

9. When all connections have been correctly made, re-connect power to the MCU.

## 9 Network Connections (Optional)

The ECU721 card transmits speech audio via a single wiring loop and digital data via two linear RS485 networks (Digital Networks 1 & 2). The network should be connected using 4 x 2-core, 1.5 mm<sup>2</sup> enhanced fire-rated cable. Maximum length on the speech wiring loop, or digital linear wiring = 1 km. We recommend that two separate cable paths be run with each path containing a single speech and single data cable (which should not be mixed in the same cable).

**Speech loop wiring:** ECU721 No.1 (Speech OUT/0V) to ECU721 No.2 (Speech IN/0V); ECU721 No.2 (Speech OUT/0V) to ECU721 No.3 (Speech IN/0V); ECU721 No.3 (Speech OUT/0V) to ECU721 No.4 (Speech IN/0V); ECU721 No.4 (Speech OUT/0V) to ECU721 No.1 (Speech IN/0V).

**Digital Network 1 wiring:** ECU721 No.1 (Digital A/B/C) to ECU721 No.2 (Digital A/B/C); ECU721 No.2 (Digital A/B/C) to ECU721 No.3 (Digital A/B/C); ECU721 No.3 (Digital A/B/C) to ECU721 No.4 (Digital A/B/C).

**Digital Network 2 wiring:** Same wiring configuration as Digital Network 1.

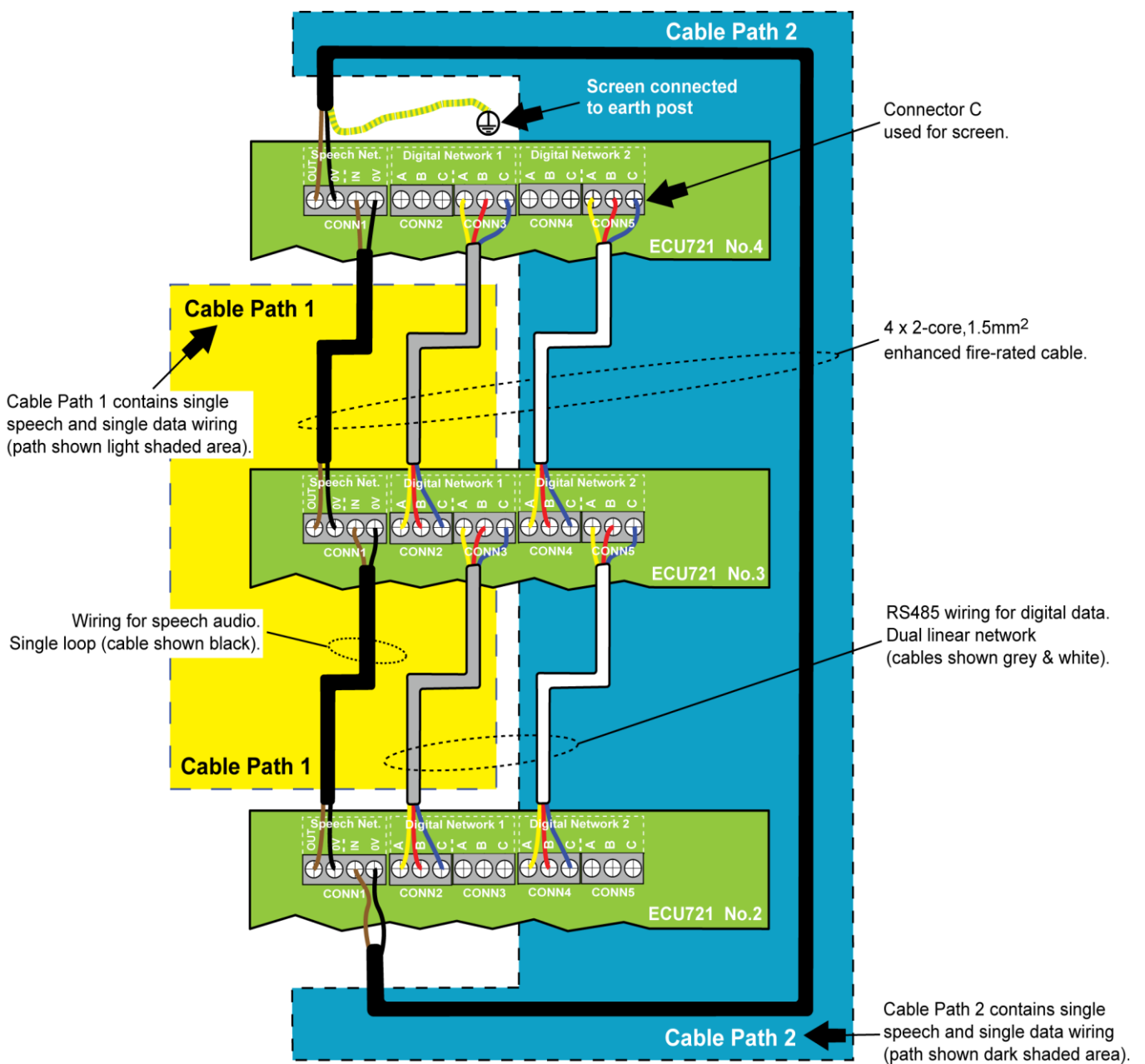



## 10 Mains Wiring

### Connect Mains to the MCU

See BS 5839-9 2003 section 13.

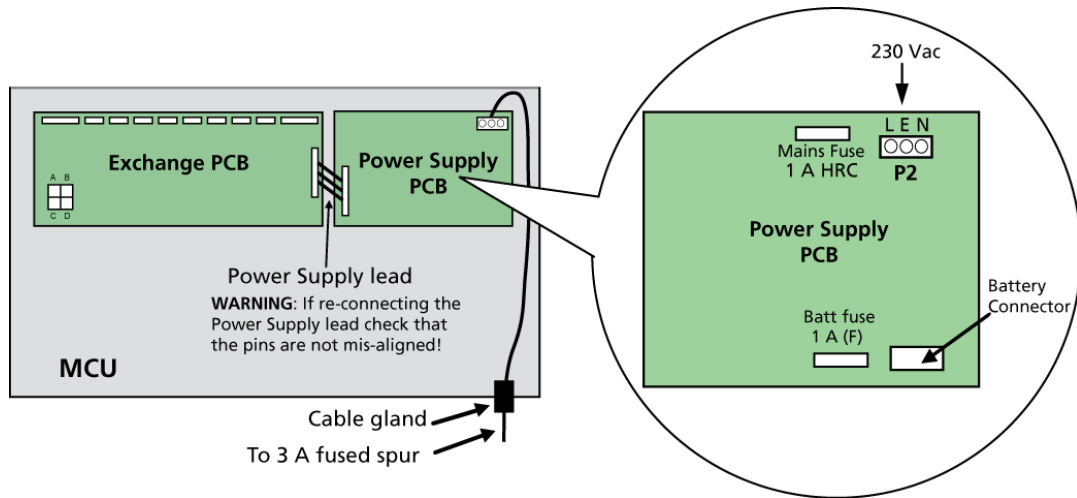

**MCU mains connections**

The MCU requires fixed wiring using 3-core enhanced fire-rated cable (no less than 0.75 mm<sup>2</sup> and no more than 2.5 mm<sup>2</sup>) fed from an isolating switched fused spur, fused at 3 amps and must not be connected using a plug and socket. The 230 VAC cable **MUST** enter the enclosure via one of the inlets at the bottom right hand corner of the enclosure.

Ensure that Mains cables are kept as far away as possible from all other cables.

Mains supply should be exclusive to the EVCS. Circuit breakers supplying power to the system should be marked 'EMERGENCY VOICE COMMUNICATION SYSTEM - DO NOT SWITCH OFF'.

A separate fused spur should be used for the MCU and should be marked 'EMERGENCY VOICE COMMUNICATION SYSTEM - DO NOT SWITCH OFF'.

See BS 5839-9 13.2 for more details.

Terminate the Mains input lead using the three-way plug supplied with the power supply PCB and ensure that correct polarity is observed.

The incoming Mains earth connection must be connected directly to the three-way plug (P2) and **NOT** to the main chassis earth-point.

The Power Supply Unit (PSU) earth strap must be connected to the main chassis earth point before operation.

## 11 Fitting Outstations & DPTA Interface

### 11.1 Cables

See section 4.

### 11.2 Location

See section 6.1.

### 11.3 Fitting type A outstation (EVC301RPO/EVC301RLK)

Open the case and unscrew the fixing screw at the bottom of the unit and remove the internal cover (see far right). This reveals the terminals and earth stud. Fix to the wall, remove the knockout above the terminals and fit a suitable cable gland. Connect the wires, as shown right.

For further details refer to Type A outstation instructions (DCM0003819).

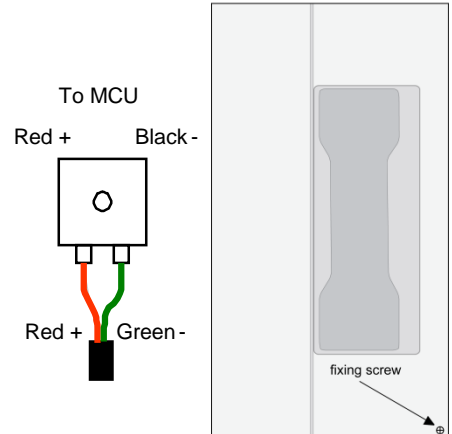

### 11.4 Fitting type B outstation (EVC302S/GS and EVC302F/GF)

Type B outstations are supplied complete with a back box that should be fitted to the wall using suitable fasteners. The back box has 20 mm knockouts at the top and bottom. Gland the cable correctly and connect a sleeved earth wire to the earth stud.

Connect the line to the LINE IN + and LINE IN – terminals.

When installation is complete, secure the lid using the four machine screws. These have a secure pin-hex design that requires a special Allen key (supplied).

For further details refer to Type B outstation instructions (DAU0302000).

### 11.5 Wiring to a disabled persons toilet alarm (DPTA)

To install the DPTA system, refer to the documentation supplied with the DPTA (Part No. NC951).

To interface the DPTA system to the EVCS see wiring diagram right. The NC951 has an existing on-board volt-free relay contact.

Two 1.5k, 0.25 W, 10% resistors are required; the EOL resistor identifies the extension as a DPTA and the trigger resistor when switched in, asserts an active alarm on the EVCS.

The 1.5K, 0.25 W resistors are supplied in the accessory pack.

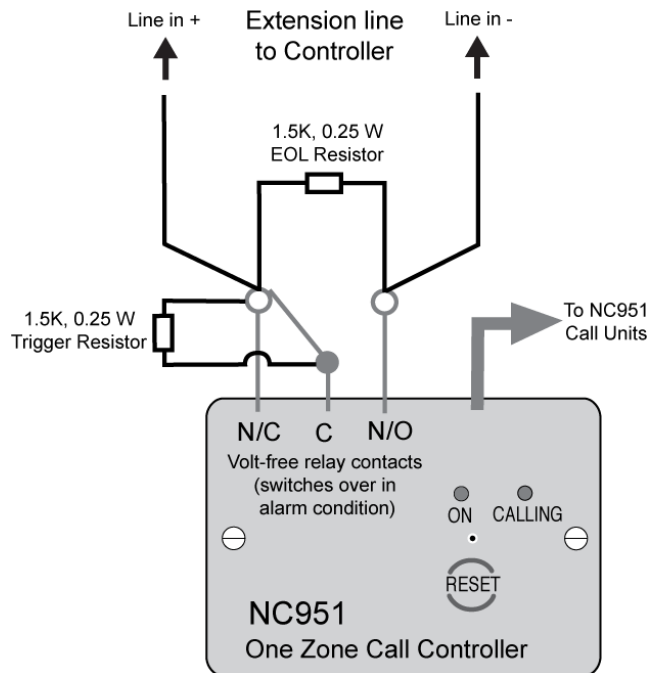

## 12 Testing Extensions

### 12.1 Insulation resistance testing

Insulation resistance testing should be carried out with no electronic devices connected. Any devices connected to the lines will be destroyed and will not be covered by factory warranty.

### 12.2 The FiTT line tester

**Note:** See Specification (section 19) for component details.

Each extension should be tested prior to termination and connection to the exchange circuit boards. We recommend that a SigTEL FiTT line tester is used to save time proving the cables and outstations are working correctly.

It also avoids the need for Mains power for testing.

If a FiTT line tester is not available, use a multimeter to check wiring for continuity and correct polarity.

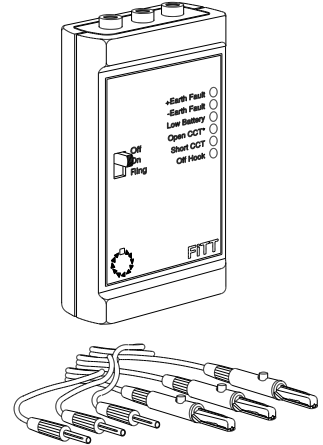

## 13 Second Fix Installation

### 13.1 Connecting extensions to the MCU and Expansion Unit

Do not connect the extensions until they have been tested and are fault-free.

Bring each extension into the case via a suitable cable gland and connect to the terminals on the exchange PCBs, as shown below. Exchange PCBs are fitted in MCU, LCU and Expansion Units.

Connect the screens to the earth terminal in the back of the case.

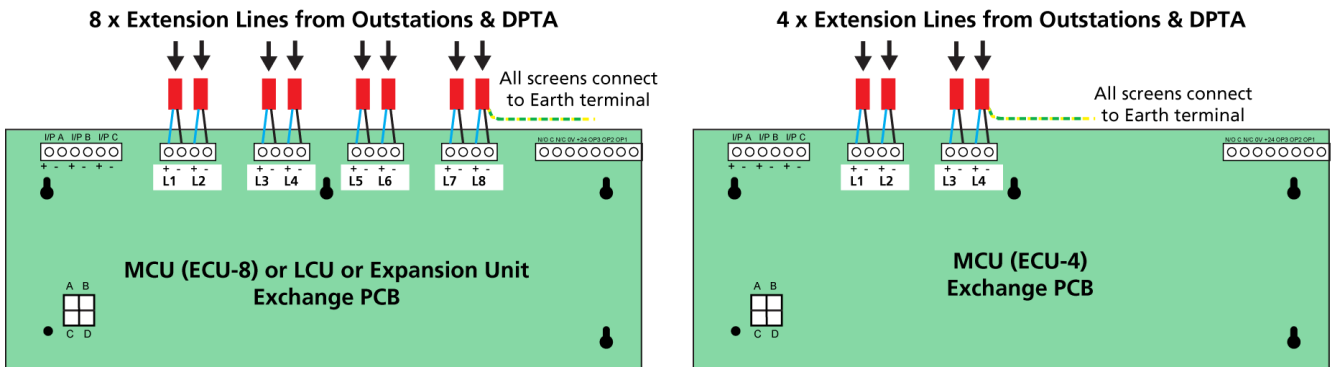

### 13.2 Fault monitoring

Once configured, the line fault monitoring system monitors for open and short circuits (absence of an outstation constitutes open-circuit).

**13.3 Input connections**

1. I/P A (Disable controls) – Disables Type A and Type B outstations.
2. I/P B (Disable controls) – Disables input signals from the DPTA.

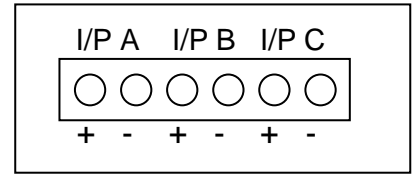

In order to prevent unauthorized use of the system it is possible to disable the controls until an external trigger is received, e.g. from a fire alarm control panel. I/P A & B are open-circuit, fail-safe system disablement inputs. Closing these inputs (shorting the connections) disables the system so that the system can then be enabled by opening the connections. No system configuration is required to use this facility and if they are left unconnected it will operate normally.

**Note:** For a network system, only one MCU requires I/P A or I/P B wiring to the disablement source.

3. I/P C - Not currently used.

**13.4 Output connections**

1. Fault output - The terminals marked N/O, C and N/C (see right) provide fail-safe fault outputs that can be connected to a fire alarm panel or other monitoring equipment.

The end-of-line device supplied with the input unit should be connected at the MCU in order to monitor the wiring (see example right). When a fault occurs the relay disconnects the end-of-line device from the fire alarm panel.

**Note:** For a network system, all MCU fault output relays will be activated.

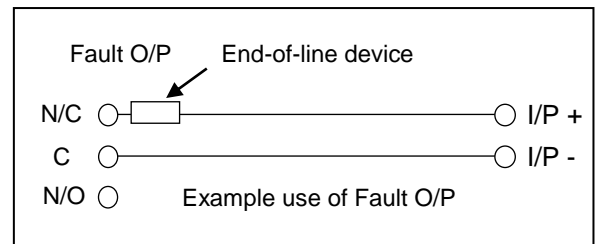
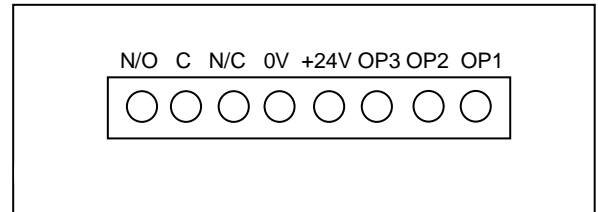

2. +24 V - Used to supply the output's auxiliary equipment, e.g. relays, etc.
3. OP1 output – activates whenever the master MCU is ringing. Its main purpose is to provide an indication (possibly remote), e.g. to a strobe, beacon, etc. when someone is seeking assistance.
4. OP2 output – provides the equivalent function as OP1 output (above) for active toilet alarms.
5. OP3 output – closes when the handset is off hook and remains active for 2 minutes after the handset is put down. This function may be used to turn off noisy equipment in the locality of the controller that may affect communication.

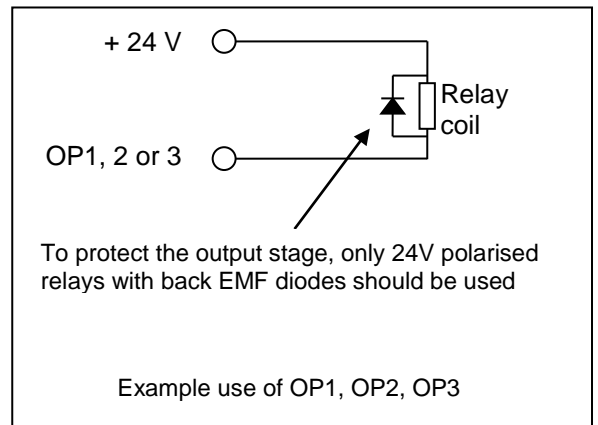

## 14 MCU Indicators & Controls

### 14.1 External indicators

Indicator	Colour	What this means
<b>Disablement</b>	Amber	The EVCS is powered up and checking for faults but the MCU is disabled from making, or receiving calls, until an external trigger is applied, e.g. from a fire alarm panel. This is NOT a fault indicator. This function is used to stop nuisance/malicious use of the EVCS until the system is required.
<b>System Fault</b>	Amber	There is a problem with the microprocessor. If this indicator cannot be extinguished, there may be a serious problem with the microprocessor. Contact the service company responsible for the EVCS.
<b>PSU Fault</b>	Amber	There is a fault with the Mains power supply or back-up batteries.
<b>General Fault</b>	Amber	There is a fault on the EVCS. The display will show more information.
<b>Power</b>	Green	Power (Mains or battery) is present.

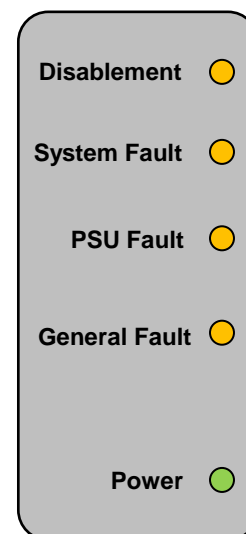

### 14.2 The display

The liquid crystal display (LCD) shows call status, system information, fault information and uses the following graphic symbols:

Graphic symbol	What this means
	MCU (ECU-8 or ECU-4)
	LCU (ECU-8NT)
	Type A (fire telephone) outstation
	Type B (disabled refuge) outstation
	Disabled persons toilet alarm (DPTA)
	The display entry is highlighted, ready to be selected

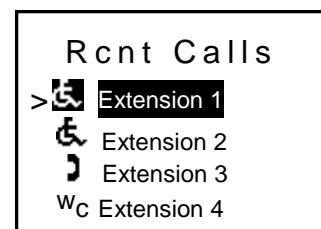

Example display

#### Display conventions

Standard / non-active displays are shown normally, e.g. ' Extension 2'

Active displays are shown reversed, e.g. '> Extension 1'

The flashing graphic symbol in front of an extension name means this extension is calling the MCU, or the MCU is calling the extension. The display's backlight also flashes red when the MCU is receiving or making a call. A reversed graphic symbol in front of an extension name means you are connected to this extension.

**14.3 External controls**

The MCU's external control buttons are located on its keypad. They are multifunction and their functions depend on the MCU's current status.

**Note:** The numbers 1, 2, 3, & 4 are used for entering security PIN codes using the keypad (by responsible persons only). This code will be provided by the system installer.

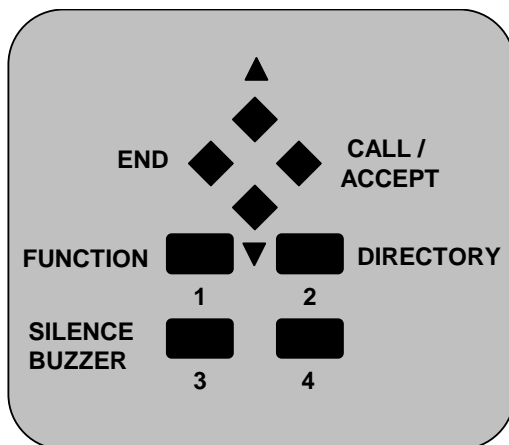

Button label	What this means	When to press this button
▲	Scroll Up	Used to scroll up and down lists (e.g. phone lists) and menus (e.g. User Options menu).
▼	Scroll Down	
<b>CALL / ACCEPT</b>	Make/Accept Calls & Select Menus	When the MCU's handset is off-hook press this button to either make an outgoing call to an extension, or accept an incoming call from an extension. Also, selects menu options.
<b>END</b>	Ends a Call & ESC back to previous display & Lamp test	When the MCU's handset is off-hook press this button to disconnect the current caller. When the MCU's handset is on-hook press this button to escape back to a previous menu. <b>Note:</b> To perform a lamp and buzzer test, press and hold this button.
<b>FUNCTION &amp; 1</b>	Additional functions & security PIN code entry	Used to access to the 'User Opts' menu.
<b>DIRECTORY &amp; 2</b>	Telephone directory & security PIN code entry	With the MCU's handset off-hook, toggles between a full list of extensions and a list of recent calls from extensions (if any). <b>Note:</b> The recent calls list is automatically cleared after a set time period (settable between 6 to 24 hours by a system engineer). Also, can be manually cleared.
<b>SILENCE BUZZER &amp; 3</b>	Silence buzzer & security PIN code entry	Used to silence the MCU's internal buzzer.
<b>4</b>	Security PIN code entry	

**14.4 Internal controls**

**Note:** The controls inside the MCU are for use by the service company responsible for the EVCS. **Under no circumstances should these internal controls be accessed by Operators.**

The Reset and an Engineer Mode buttons are located on the Control PCB inside the front lid. The Engineer Mode button is used to allow configuration and testing of the system. The Reset button is normally only used to manually initiate a clean restart to the system, or to reset test calls that have been made from unassigned Type B outstations.

## 15 Fault Messages

Faults on the EVCS are normally non-latching and will clear if the fault disappears. The only exception being a watchdog fault which occurs at initial power-up, or after a system reset and stays latched until manually cleared. Normally this fault clears when accepted and the MCU reverts to normal operation.

If the EVCS has been configured previously and any extensions are now missing, or are incorrectly connected the relevant faults are displayed.

The display (right) show typical displays but may have a different number of faults.

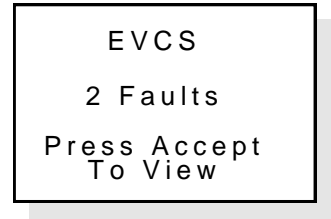

Press CALL / ACCEPT button to view the fault(s).

Each fault display has two lines. The format depends on whether the fault relates to an extension or not.

<p><b>Format 1: Extension faults</b>                  Line 1 - Extension name                  Line 2 - Fault description</p>	<p><b>Format 2: Non-extension faults</b>                  Line 1 - Fault description, e.g. Mains fail                  Line 2 - Blank</p>
---	---

### Clearing faults

Most faults can be cleared in turn (e.g. watchdog fault), by pressing the CALL/ACCEPT button. Each fault that is no longer present will clear and the next fault will be presented.

You can also press ▲ and ▼ to navigate through the faults and select which ones to clear.

### Remaining faults

All outstation faults should be cleared before configuration. Some faults, such as Mains fail when setting up on batteries, may not clear and will stay on the display. Some faults may require investigation, or assistance from the service company responsible for the EVCS. If required, contact them directly for assistance quoting the exact nature of the fault which is shown on the display.

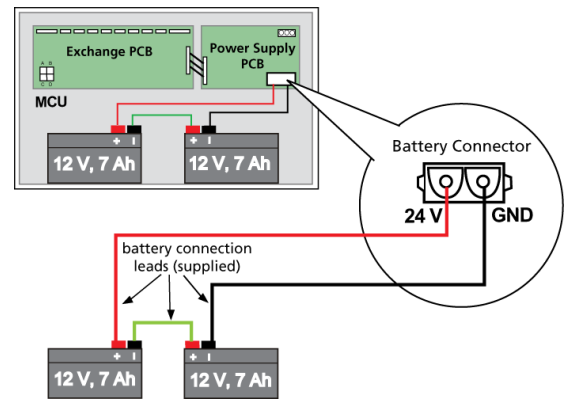

## 16 Powering Up and Testing

### Setup using batteries

These instructions assume that the system is being set up and configured on batteries only. If it is configured on Mains only, or Mains and batteries, the fault displays will change accordingly.

Two 12 volt, 7 Ah VRLA batteries (BC286/2) should be used with each MCU. These should be connected in series using the link supplied with each unit. The terminal voltage of the batteries must be at least 22 V.

Do not leave batteries attached for long time periods whilst the Mains is not connected, or is subject to disruption as they will become fully discharged and will have to be replaced.

### Setup using Mains

Fit a 3 amp fuse into the switched fused spur and turn the power on.

### Turn the power on

As soon as the MCU receives power the handsets may ring for a moment and the MCU will sound an intermittent fault buzzer due, at least, to a Watchdog Fault. The Power LED, System Fault LED, PSU Fault and General Fault LED will be lit.

Cancel the fault buzzer by pressing SILENCE BUZZER button.

**Check the outstations are working**

Go to each outstation in turn.

At Type A outstations, the LED on the handset cradle will be lit. Pick up the handset and speak. If you hear yourself in the earpiece then it is correctly connected.

At Type B outstations press the 'Push to Call or Answer' button and the red LED will light. This cannot be cancelled so when you have finished checking them all, press the Reset button inside the MCU's lid.

When all outstations are working, clear the fault display to make sure that there are no other problems and then use Auto Learn option to begin the system configuration (see section 17). If faults are present, handsets are off-hook, or call/answer buttons have been pressed, then the Auto Learn option will abort.

**Check the toilet alarms are working**

Go to each toilet alarm system in turn. Initiate an alarm from a call unit on each system and confirm the call is displayed at the MCU. Ensure all toilet alarms are cleared and reset.

**Note:** Toilet alarms can only be reset at the alarm point and cannot be reset at the MCU.



## 17 Automatic Configuration

If the fault menu is displayed, press END button to exit the menu. The backlight will go out and the display will say 'System Healthy', or display the number of faults.

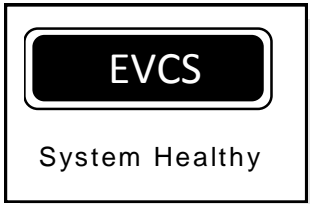
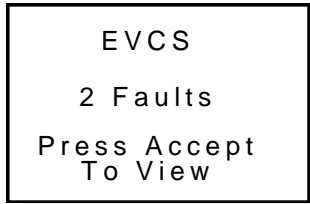

### 17.1 Non-networked MCU configuration

**Note:** If a networked MCU system is being configured refer to section 17.2.

Before configuring the system, ensure the MCU, all outstations and DPTA interfaces have been installed, connected and tested. Ensure that all handsets are on-hook and toilet alarms are cleared and reset.

1. Open the MCU lid and press the Engineer Mode button.  
The 'Eng. Opts' menu is displayed. Press ▼ to highlight the 'Config' option and press CALL/ACCEPT button.

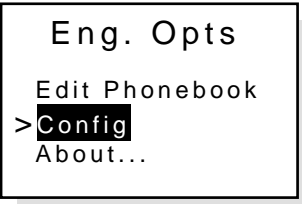

2. The 'Config' menu is displayed.  
'System Cfg' option is highlighted. Press CALL/ACCEPT button.

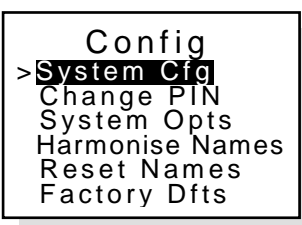

3. The 'Sys Cfg' menu is displayed.  
'Unit Count' option is highlighted.  
**Ensure that the unit count is set to 1.**

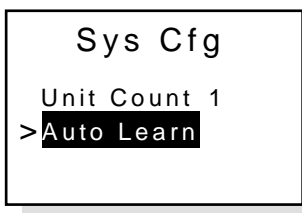

Press ▼ to highlight 'Auto Learn' option and press CALL/ACCEPT.

4. The system will automatically perform an Auto Learn and detect the attached extensions. The Auto Learn system configuration is displayed at the MCU.  
The ☒ symbol denotes the number of MCU (ECU-8 or ECU-4) on the system.

**Note:** This is limited to one unit for a non-networked system.

The ⌋ symbol denotes the number of Type A (fire telephone) outstations.

The & symbol denotes the number of Type B (disabled refuge) outstations.

The W<sub>C</sub> symbol denotes the number of DPTA on the system.

Check the number of ⌋ and & and W<sub>C</sub> match the number of connected extensions.

**Note:** If at this stage there is a mismatch between the expected and the displayed number of system devices, press the CALL/ACCEPT button again at the MCU whilst the Auto Learn system configuration is displayed. This will cause the system to perform another learn of the devices on the system.

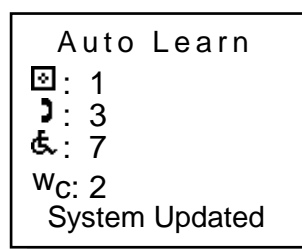

5. Press END button multiple times to exit to the system healthy display. The system is now configured and can be used. Add/edit extension names at this point (see naming extensions – sections 17.5).

**17.2 Networked MCU configuration**

**Note:** If a single, non-networked MCU is being configured refer to section 17.1.

Before configuring the network, ensure all MCU, outstations and DPTA interfaces have been installed, connected and tested. Ensure that all handsets are on-hook and toilet alarms are cleared and reset.

The network requires one MCU to be nominated as the master MCU for commissioning purposes. This MCU will have overall control of the EVCS. The remaining MCU on the network act as repeaters but have the ability to take control from the master MCU by entering a security PIN code, after configuration.

**Select a master MCU**

1. At the chosen master MCU, open the lid and press the Engineer Mode button. The 'Eng. Opts' menu is displayed.
2. Press ▼ to highlight the 'Config' option and press CALL/ACCEPT button.

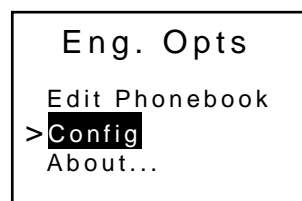

3. The 'Config' menu is displayed. 'System Cfg' option is highlighted. Press CALL/ACCEPT button.

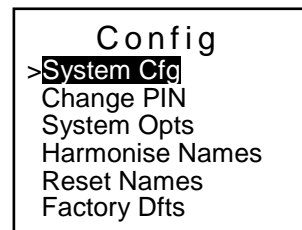

4. The 'Syst Cfg' menu is displayed. 'Unit Count' option is highlighted. Press CALL/ACCEPT button to select the Unit Count number.

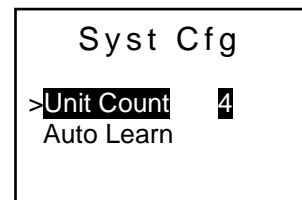

Press ▼ or ▲ to set the total number of MCU on the network including the master MCU, (either 2, 3, or 4) and press CALL/ACCEPT button.

The master MCU then requests repeater MCU to join it on the network.

5. Go to a repeater MCU and press CALL/ACCEPT button to join the network. Repeat this step for all remaining repeater MCU on the network.

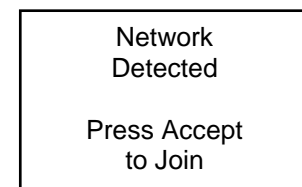



- After all repeater MCU have joined the network, the system will automatically perform an Auto Learn and detect the attached extensions. The Auto Learn system configuration is displayed at the master MCU, see example below right.

**Note:** If a fault message is displayed at the master MCU an Auto Learn may not have been performed. Press END button to exit the fault menu and start the Auto Learn process.

The  symbol denotes the number of MCU (ECU-8 or ECU-4) on the network.

**Note:** This is a maximum of 4 units for a networked system.





The  symbol denotes the number of LCU (ECU-8NT).

The  symbol denotes the number of Type A (fire telephone) outstations.

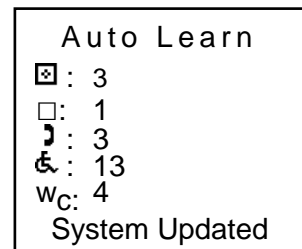
The  symbol denotes the number of Type B (disabled refuge) outstations.

The  $W_C$  symbol denotes the number of DPTA on the system.



Check the number of  and  and  and  and  $W_C$  match the number of network devices.

**Note:** If at this stage there is a mismatch between the expected and the displayed number of network devices, press the CALL/ACCEPT button again at the master MCU whilst the Auto Learn system configuration is displayed. This will cause the system to perform another learn of the network devices.

- Press END button multiple times to exit to the system healthy display. The master MCU and repeater MCU will display their network status. See examples below.



Networked 'master' MCU

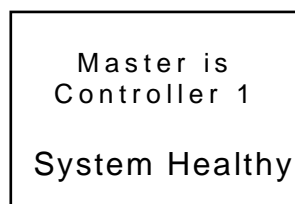

Networked 'repeater' MCU

The system is now configured and can be used.

**Note:** Extension names can be added/edited at this point (see naming extensions – sections 17.5).

17.3 Adding or replacing MCU, outstations or DPTA after commissioning

Note: Compatibility issues may arise if adding/replacing a controller panel with the latest firmware onto a networked system with earlier firmware. Some features of the new firmware may be disabled/unavailable to ensure smooth compatibility with the panels with earlier firmware. If the latest features are required, the other panels on the network must be replaced.

Firstly, make the necessary electrical or mechanical changes and all faults are cleared on the system.

To add an MCU (network system): Open the lid of the MCU and press the Engineer Mode button. Select the 'Config' menu, then 'System Cfg' menu, and then select 'Unit Count' option. Press ▼ or ▲ to set the number of MCU on the network including the master MCU (either 2, 3, or 4) and press CALL/ACCEPT button. The master MCU then requests repeater MCU to join it on the network. If an MCU is joining the network, go to that MCU and press CALL/ACCEPT button. The system will automatically perform an Auto Learn, search the network for all MCU and display the system configuration at the master MCU.

To replace a faulty MCU (network system): Make sure that the faulty panel you are replacing is not the designated 'Master'. At the master MCU, open the lid and press the Engineer Mode button. Select the 'Config' menu, then 'System Cfg' menu, and then select 'Unit Count' option. Press ▼ or ▲ to set the number of MCU on the network including the master MCU (either 2, 3, or 4) and press CALL/ACCEPT button. The master MCU then requests repeater MCU to join it on the network. If an MCU is joining the network, go to that MCU and press CALL/ACCEPT button. The system will automatically perform an Auto Learn, search the network for all MCU and display the system configuration at the master MCU.

To add/remove an outstation or DPTA (non-network and network system): Open the lid of the master MCU and press the Engineer Mode button. The 'Eng. Opts' menu is displayed. Select the 'Config' menu, then 'System Cfg' menu, and then select 'Auto Learn' option. The system will automatically perform an Auto Learn and search for connected extensions. The system configuration is displayed at the MCU (or master MCU on a networked system).

17.4 Default extension names

On a networked system, the controller (MCU & LCU) extensions are allocated the following default names:

- Controller 1: Extension 1 to Extension 16
Controller 2: Extension 17 to Extension 32
Controller 3: Extension 33 to Extension 48
Controller 4: Extension 49 to Extension 64.

17.5 Naming extensions

Open the lid of the MCU (or, in the case of a networked system, the master MCU) and press the Engineer Mode button. The 'Eng. Opts' menu is displayed.

Select 'Edit Phonebook' option, see right.

A list of all system devices will be displayed:

☒ or ☐ or ⌋ or ⌋ with symbol or Wc symbols denote whether they are an MCU, LCU, Type A outstation, or Type B outstation, or DPTA, see far right.

Note: The symbol ☒ will only appear on a networked system.

To edit the extension names, see manual naming section 17.5.2.

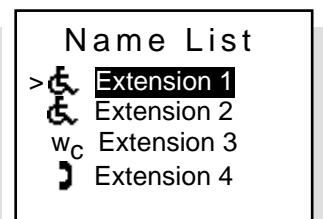
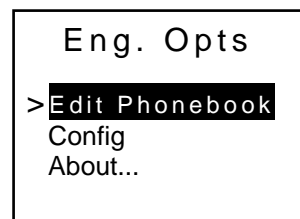

17.5.1 Interactive naming

This function reduces the chance of errors with outstation locations and their names. It also tests that the audio is working acceptably. This function has limited use when naming toilet alarms as you cannot make an audio call to the MCU using the toilet alarm.

With a person at the MCU (or, in the case of a networked system, the master MCU) go to each outstation in turn. At each outstation, pick up the handset, or press 'Push to Call or Answer' button. This automatically selects that outstation for editing and the channel is opened for speech.

Check the audio quality of the line and tell the Operator at the MCU your position and they can edit the extension name immediately – see Manual naming, below.

**Note:** To avoid confusion, select one extension at a time during the naming process. If more than one extension is selected during this process, the lowest number will be selected for editing.

17.5.2 Manual naming

Press ▲ and ▼ to highlight the extension you want to name and then press CALL/ACCEPT button to select the first letter, as shown right.

Press ▲ and ▼ to change the letter, press CALL/ACCEPT button to accept and move to the next letter and press END button to move to the previous letter.

Press FUNCTION button to change the character set as follows:

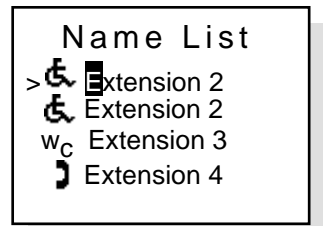

Starting with letter 'E' for example	Starting with a non-alphabetic character
1st press changes to lower case 'e'	1st press changes to characters 'SPACE'
2nd press changes to characters 'SPACE'	2nd press changes to numbers '0'
3rd press changes to numbers '0'	3rd press changes to upper case 'A'
4th press returns to upper case 'E'	4th press returns to lower case 'a'

**Character set**

*Characters* - SPACE! " # \$ % & ' < > \* + , - . /

*Numbers* - 0 1 2 3 4 5 6 7 8 9 : ; < = > ? @

*Uppercase* - A B C D E F G H I J K L M N O P Q R S T U V W X Y Z [ \ ] ^ \_ °

*Lower case* - a b c d e f g h i j k l m n o p q r s t u v w x y z @ ( )

When you have finished editing an extension, press DIRECTORY button to save the changes and then ▲ and ▼ to select another extension to name.

When you have finished naming extensions, press END button multiple times to return to the default screen.

If you want to cancel editing an extension name, press button '4' to return to the previously saved description.

17.5.3 EVC Configurator

The EVC423 Configurator, supplied with software and leads, facilitates quick and easy editing of extension names and also provides limited engineering functions. Features include:

- Graphical representation of the EVCS including controllers and connected extensions
- Quick and easy editing of extensions names
- Set up can be saved to, and from, a PC
- Requires a Configurator (Part No. EVC423) and a PC/Laptop (Windows compatible), loaded with the EVCS Configurator software.

Contact your supplier for details.

## 18 Additional Engineer Functions

### 18.1 Change the security PIN code

**Note:** For a networked system, this option can only be accessed at the master MCU. The default security PIN code is 2222.

1. Open the lid of the MCU and press the Engineer Mode button. The 'Eng. Opts' menu is displayed.
2. Press ▼ to highlight the 'Config' option and press CALL/ACCEPT button.

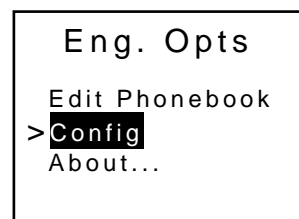

3. The 'Config' menu is displayed.  
Press ▼ to highlight 'Change PIN' option and press CALL/ACCEPT button.

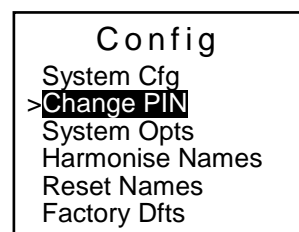

4. Enter, then re-enter the new PIN number. Press CALL/ACCEPT button to confirm the PIN number change.  
Press END button multiple times to exit to the system healthy display.

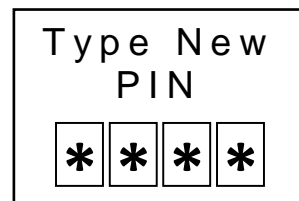

### 18.2 Harmonise names (networked system only)

Harmonise Names option is used to globally update all network settings, e.g. security PIN code changes, extension names, etc. This option is not normally required but could be used, for example, to update the extension name list if there was a mismatch on the controller panels.

1. Follow steps 1 and 2, previously listed in section 18.1, to access the 'Config' menu.
2. Press ▼ to highlight 'Harmonise Names' option and press CALL/ACCEPT button.

All network settings will be updated globally on the network.

After the harmonisation process is complete, press END button multiple times to exit to the system healthy display.

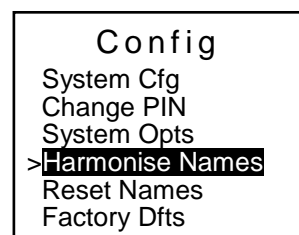

**18.3 Latch faults**

**Note:** For a networked system, this option can only be accessed at the master MCU.

Latch Faults option is not normally enabled but is available, if required, for fault diagnosis purposes, e.g. identifying intermittent faults.

1. Open the lid of the MCU and press the Engineer Mode button. The 'Eng. Opts' menu is displayed.
2. Press ▼ to highlight the 'Config' option and press CALL/ACCEPT button.



3. The 'Config' menu is displayed.  
Press ▼ to highlight the 'System Opts' option and press CALL/ACCEPT button.

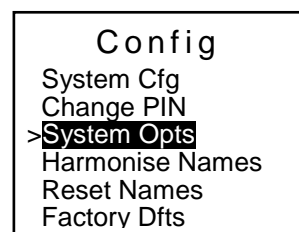

4. The 'System Opts' menu is displayed and the 'Latch Faults' option is highlighted.

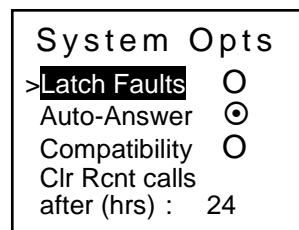

5. Press CALL/ACCEPT button to select the 'Latch Faults' option.  
Press END button multiple times to exit to the system healthy display.

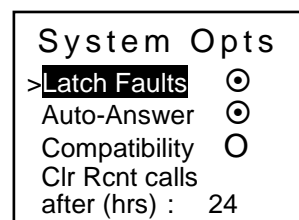

**18.4 Clear recent calls**

**Note:** For a networked system, this option can only be accessed at the master MCU.

Clear Recent Calls enables the call activity log, held by the system, to be automatically cleared after a set time period. It can be set at hourly increments from 6 to 24 hours (default setting is 24 hours).

- 1. Follow steps 1, 2 & 3, previously listed in section 18.3, to access the 'System Opts' menu.
- 2. Press ▼ to highlight 'Clr Rcnt calls after (hrs)' option and press CALL/ACCEPT button.

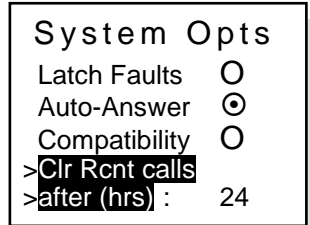

- 3. Press ▼ or ▲ to set the time in hours, e.g. 6 hours, and press CALL/ACCEPT button to confirm the setting.  
Press END button multiple times to exit to the system healthy display.

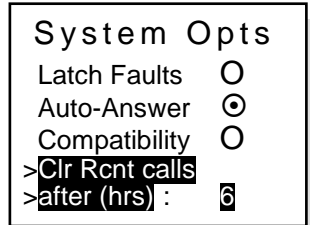

**18.5 Auto-answer**

**Note:** For a networked system, this option can only be accessed at the master MCU.

By default Auto-Answer mode is enabled, which means an MCU automatically answers an incoming call when the MCU's handset is picked up. This provides a simple method of answering calls.

When Auto-Answer is enabled, and there are multiple incoming calls, there is less control for an Operator to manually select which call to answer first, or to make an outgoing call. As a rule, the lowest *system* numbered extension will be answered first at the MCU.

To disable Auto-Answer mode and revert to Manual-Answer mode follow the steps below:

- 1. Follow steps 1, 2 & 3, previously listed in section 18.3, to access the 'System Opts' menu.
- 2. Press ▼ to highlight 'Auto-Answer' option.

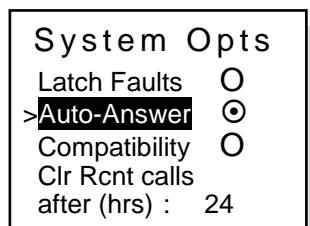

- 3. Press CALL/ACCEPT button to disable the 'Auto-Answer' option.  
Press END button multiple times to exit to the system healthy display.

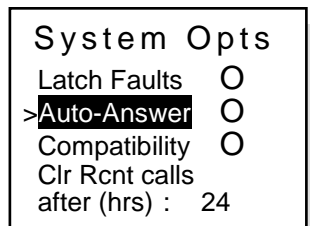



## 19 Component Specifications

Note: The following specification applies to MCU (ECU-8 and ECU-4) & LCU (ECU-8NT), unless stated.

<b>Power Supply and Batteries</b>	
Mains supply	230 VAC, 50/60 Hz
Power supply output 1	24 VDC
Power supply output 2	5 VDC
Output current @ 24 VDC	0.5 A max.
Batteries per MCU	2 x 12 V, 7 Ah (Part No. BC286/2)
Mains supply/battery charger monitored for failure	Yes
Batteries monitored for disconnection and failure	Yes
Earth fault monitoring	Yes
<b>Quiescent current when operating on batteries only</b>	
MCU only with Mains fault buzzer silenced	85 mA
MCU only with Mains fault buzzer sounding	100 mA
MCU + Expansion Unit	105 mA
MCU + Expansion Unit with Mains fault buzzer sounding	120 mA
Quiescent current per Type A outstation	1 mA
Quiescent current per Type B outstation	3.2 mA
Off-hook current per Type A outstation	25 mA
Off-hook current per Type B outstation	25 mA
Max current *	500 mA
<i>* 16 Type B outstations fitted; one connected, 15 calling in.</i>	
<b>Output Ratings</b>	
OP1, OP2, OP3 open collector outputs	24 V, 50 mA max.
Change-over relay	30 V, 1 A max.
24 V output	200 mA max.
<b>Audio Section</b>	
Microphone frequency response	250 Hz to 5 kHz +/- 3 dB
Earpiece frequency response	250 Hz to 4 kHz +/- 3 dB
Loudspeaker frequency response	
<b>Extension Specification</b>	
Max. number of extensions per MCU	8 (ECU-8), 4 (ECU-4)
Number of outstations or DPTA per extension	1
Max. number of Expansion Units per MCU	1
Extensions monitored for open-circuit and short-circuit	Yes
<b>Fuses</b>	
Mains fuse	1 A (T) 20 mm HRC
Battery fuse	1 A (F) 20 mm
<b>DPTA Resistors</b>	
EOL & trigger resistors	1.5K, 0.25 W, 10% (supplied in accessory pack)
<b>Cables</b>	
Extensions to outstations	2-core, 1.0 mm <sup>2</sup> or 1.5 mm <sup>2</sup> , enhanced fire-rated cable, up to 1 km per extension (max. cable resistance is 40 ohms).
Extensions to DPTA systems (NC951)	2-core enhanced fire-rated cable is required for each extension.
MCU Power supplies	Fixed wiring using 3-core fire-rated cable (no less than 0.75 mm <sup>2</sup> and no more than 2.5 mm <sup>2</sup> ) fed from an isolating switched fused spur, fused at 3 amps and must not be connected MCU using a plug and socket.
MCU to Expansion Unit	Two Cat 5 patch leads (supplied with Expansion Unit).
MCU to MCU – networked system	4 x 2-core, 1.5 mm <sup>2</sup> enhanced fire-rated cable, up to 1 km in length.
MCU to ECU721 – networked system	One Cat 5 patch lead (supplied with ECU721).
<b>Controls &amp; Indicators</b>	
Liquid Crystal Display (LCD)	128 x 64 pixel graphic LCD unit, two-colour backlight
Controls (pushbuttons)	Scroll Up ▲, Scroll Down ▼, End, Call/Accept, Function, Directory, Silence Buzzer, Four numbered buttons (1, 2, 3 & 4)
Indicators (LEDs)	Disablement (Amber), System Fault (Amber), PSU Fault (Amber), General Fault (Amber), Power (Green)
Internal controls (pushbuttons)	Engineer Mode, Reset
<b>Case Colours</b>	
MCU and Expansion Unit	Label background Pantone 429C. Lid and base RAL7035 (Grey texture)
EVC301RPO and EVC301RLK	RAL 3000 (Red)
EVC302F/GF and EVC302S/GS	Fascia stainless steel (EVC302F and EVC302S), Fascia mild steel green (EVC302GF and EVC302GS). Base RAL 9005 (Jet Black)

Dimensions & Weight (unpacked)	
MCU	435 mm (w) x 270 mm (h) x 85 mm (d). Weight: 3.1 Kg
Expansion Unit	435 mm (w) x 270 mm (h) x 85 mm (d). Weight: 3.1 Kg
Enclosure BF359/3D	725 mm (w) x 448 mm (h) x 193 mm (d). Weight 11.1 Kg
Type A Outstation EVC301RPO/RLK	202 mm (w) x 278 mm (h) x 100 mm (d). Weight: 3 Kg
Bezel T-BEZ301	244 mm (w) x 320 mm (h) x 20 mm (d). Weight: 0.5 Kg
Type B Outstation EVC302S/GS	160 mm (w) x 240 mm (h) x 53 mm (d). Weight: 1.3 Kg
Type B Outstation EVC302F/GF	175 mm (w) x 250 mm (h) x 53 mm (d). Weight: 1.5 Kg
Enclosure BF359/1	200 mm (w) x 302 mm (h) x 123 mm (d). Weight: 3.3 Kg
FiTT	77 mm (w) x 135 mm (h) x 35 mm (d). Weight: 0.16 Kg
SDM	48 mm (w) x 60 mm (h) x 30 mm (d). Weight: 0.003 Kg

## 20 EVCS Standby Battery Calculation Guide

The standby time of the EVCS, after the Mains has failed, depends on the quiescent loading of the system, the alarm load of the system and the capacity of the batteries.

To determine the capacity of batteries required for any given standby period, the following formula should be used:

$$\text{Battery Capacity (in Ah)} = 1.25 \times [(T \times A) + H \times (P + Z)]$$

The multiplier 1.25 is present to account for lost capacity over the life of the batteries.

**T** = Total off-hook time for the outstations

**A** = Total off-hook current for the outstations

**H** = Number of hours standby required

**P** = Quiescent current of the ECU-8 (85 mA) + ECU-8S (20 mA) = 0.11 A

**Z** = Total quiescent current of outstations

**Example:** The EVCS has one Master Control Unit (ECU-8), one Expansion Unit (ECU-8S), six Type A fire telephone outstations (EVC301) each consuming 0.001 A and seven Type B disabled refuge outstations (EVC302) each consuming 0.0032 A. When off-hook, there will be a load of 0.025 A with a required off-hook time of 3 hours. The required standby time is 24 hours.

---

Calculate the alarm capacity: **(T x A)**

**T** = 3 hours; **A** = 0.025 A

The alarm capacity = (3 x 0.025)

$$= 0.075 \text{ Ah}$$

---

Calculate the quiescent capacity: **H x (P + Z)**

**H** = 24 hours; **P** = 0.11 A; **Z** = (6 x 0.001 A) + (7 x 0.0032 A)

The quiescent capacity = 24 x (0.11 + 0.029)

$$= 3.34 \text{ Ah}$$

---

Therefore, battery capacity = 1.25 x [0.075 + 3.34]

$$= 4.27 \text{ Ah}$$

## 21 Enhanced Features

As the firmware for the SigTEL Compact range of panels has been developed, new enhanced features have been added. The enhanced features and corresponding firmware versions are listed in Table 1, below:

		Firmware Version				
		V 2.2.1	V 2.5.14	V 2.6.14	V 3.1.17	V 4.1.2 (or above)
<b>Enhanced Features</b>	Network Capability	x	✓	✓	✓	✓
	Latch Faults	x	x	✓	✓	✓
	Selectable Time for 'Auto-Clear Recent Calls'	x	x	✓	✓	✓
	Auto-Answer	x	x	✓*	✓*	✓**
	Off-Hook and Jammed Button Detection	x	x	✓	✓	✓
	DPTA Interface	x	x	x	✓	✓
	PC Tools Support for EVCS	x	x	x	x	✓
	OP3 activates on system use	x	x	x	x	✓
<b>Installation &amp; Configuration Manual</b>		DAU0000091				
<b>Operator Instructions</b>		DAU0000092				
<b>Quick Start Installation Guide</b>		DAU0000093				

**Table 1 – Enhanced Features for SigTEL Compact**

\* In default mode Auto-Answer feature is disabled.

\*\* In default mode Auto-Answer feature is enabled.

### 21.1 Firmware version

To find out which firmware version is installed on the EVCS follow the steps below:

1. At the MCU, with the handset on-hook, press FUNCTION button.
2. The 'User Opts' menu is displayed (see right).
3. Press the down cursor ▼ on the keypad to highlight the 'About...' option and press CALL/ACCEPT button. The firmware version is displayed (typical display shown right).

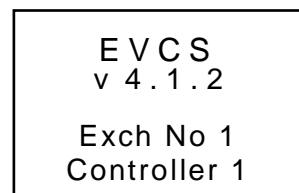
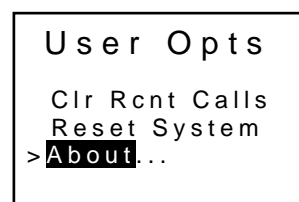

Note: Compatibility issues may arise if adding/replacing a panel with the latest firmware onto a networked system with earlier firmware. Some features of the new firmware may be disabled/unavailable to ensure smooth compatibility with the panels with earlier firmware. If the latest features are required, the other panels on the network must be replaced. Should there be any technical problems with SigTEL Compact, contact the technical support department for assistance.

## 22 Installation and Commissioning Certificate

Before the system and the Operator Instructions are handed over to the responsible person on site, the following certificate should be completed by the installer, or commissioning engineer.

### Certificate for the EVCS at:

Address:

I/we being the person(s) responsible (as indicated by my/our signatures below) for the supply, installation and commissioning of the EVCS, particulars of which are set out below, certify that the system complies to the best of my/our knowledge and belief with the recommendations of BS5839-9:2002, except for the variations, if any, stated in this certificate.

Name (in block letters): \_\_\_\_\_ Position: .....

Signature: \_\_\_\_\_ Date: \_\_\_\_\_

For and on behalf of:

Address:

Postcode:

The extent of liability of the signatory is limited to the system described below.

Variations (see BS5839-9, Clause 6): .....

All equipment operates correctly.

The following documents have been provided to the purchaser or user:

'As fitted' drawings.

Operating and maintenance instructions.

Sufficient representatives of the user have been properly instructed in the use of the system.

### Maintenance

It is strongly recommended that, after completion, the system is tested, inspected and serviced in accordance with Section five of BS5839-9:2003.

The user should appoint a responsible person to supervise all matters pertaining to the EVCS in accordance with the recommendations of Section six of BS 5839-9:2003.

## 23 Terms and Definitions

For the purposes of these instructions the following terms and definitions apply:

**disabled persons toilet alarm (DPTA) interface**

DPTA interfacing is a secondary function to the primary purpose of the system which is to act as an EVCS. Toilet alarms can only be reset at the alarm point and cannot be reset by the EVCS. DPTA part number: NC951.

**disabled refuge system**

type of EVCS. A disabled refuge system connects hands-free Type B (disabled refuge) outstations to an MCU and is used during a fire emergency to inform a responsible person that someone needs immediate assistance to evacuate from the building.

**emergency voice communication system (EVCS)**

system that allows voice communication in either direction between an MCU and a number of other points throughout a building, or building complex, particularly in a fire emergency situation. There are two types of EVCS; disabled refuge systems and fire telephone systems. They may be separate, or they may be combined into one system and are designed to operate reliably in a fire emergency.

**extension**

each MCU has either eight extensions (ECU-8) or four extensions (ECU-4). This can be increased to 16 extensions using an Expansion Unit with an ECU-8, or to 12 extensions using an Expansion Unit with an ECU-4. One extension typically has one outstation (Type A or B) or a DPTA connected to it.

**fire telephone system**

type of EVCS. A fire telephone system connects Type A outstations to an MCU and is used by management, marshals at a sports ground and the fire service before, during and after a fire to communicate with fire marshals and fire fighters.

**handset**

telephone-style handset used for voice communication. MCU and Type A outstations both have handsets.

**line control unit (LCU)**

control unit that controls the EVCS. On a networked system, up to four MCU and/or LCU can be installed. The LCU is identical to an MCU but does not have a handset mounted on its front fascia. Part number: ECU-8NT.

**master control unit (MCU)**

control unit that controls the EVCS. On a networked system, up to four MCU and/or LCU can be installed. The MCU has a handset mounted on its front panel. Part number: ECU-8 or ECU-4.

**master MCU**

control unit on a network that has control over the EVCS, i.e. the 'master'. Any other MCU on a network acts as a repeater. The master MCU can give control to a repeater MCU by entering a security PIN code. There can only be one master MCU at any one time. Part number: ECU-8 or ECU-4.

**network**

communication link between MCU located at different control points.

**off-hook**

status of a handset when picked up from its normal rest position to initiate an outgoing call, or receive an incoming call.

**on-hook**

status of a handset when in its normal rest position, notification of an incoming call, or terminating a call.

**outstation**

unit located at a strategic point in a building, or building complex, that allows two-way voice conversation with an MCU. There are two types; Type A (fire telephone) and Type B (disabled refuge).

**repeater MCU**

control unit that forms part of a networked EVCS. They repeat messages displayed at the master MCU and have the ability to take control from the master MCU by entering a security PIN code. Part number: ECU-8 or ECU-4.

**type A (fire telephone) outstation**

outstation that uses a telephone-style handset for communication. The housing consists of a wall-mounted, red steel cabinet that should be located at entrances and fire fighting lobbies. Type A enclosures may be lockable, in which case, keys must be issued by the person responsible for the EVCS.

Part numbers: EVC301RPO/EVC301RLK.

**type B (disabled refuge) outstation**

outstation that uses an intercom-style unit with a call/answer button and built-in microphone and loudspeaker. The outstation uses hands-free, duplex operation and should be located in disabled refuges at each storey exit. Part numbers: EVC302S/EVC302GS or EVC302F/EVC302GF.